



Li-PRO Series

User Manual

Version 1.0



Document History

| Date | Version | Chapter | Description | Author |
|----------|---------|---------|----------------|--------|
| 2024/6/4 | V1.0 | | First Version. | Peng |



| | | |
|----------|-----------------------------------------|-----------|
| 1 | Safety Precautions | 1 |
| 1.1 | General Safety | 1 |
| 1.2 | General Safety Precautions | 1 |
| 1.3 | Battery Handling Guide | 2 |
| 2 | System Application Introduction | 3 |
| 2.1 | PV Self-use Surplus Power to Grid | 3 |
| 2.2 | Peak Shaving and Valley Filling | 3 |
| 2.3 | Standby Power Supply | 3 |
| 3 | Product Specification | 4 |
| 3.1 | System Description | 4 |
| 3.2 | Appearance, Weight and Dimensions | 4 |
| 3.3 | Battery Parameters | 6 |
| 3.4 | Packing List | 6 |
| 3.5 | System Drawing | 7 |
| 3.6 | Interface Description | 8 |
| 3.7 | LED Display Definition | 9 |
| 4 | Preparation before Installation | 10 |
| 4.1 | Selection of Installation Location | 10 |
| 4.2 | Environment Requirement | 10 |
| 4.3 | Installation Carrier Requirement | 11 |
| 4.4 | Clearance Requirement | 11 |
| 4.5 | Tools Requirement | 12 |
| 4.6 | Installation steps | 13 |
| 4.7 | Installation Options | 14 |
| 4.8 | Installation Procedure | 16 |
| 5 | Appendix1 | 16 |
| 6 | Appendix2 | 17 |
| 7 | Appendix3 | 21 |
| 7.1 | Abnormal Situation Addressing | 21 |
| 7.2 | Product Responsibilities and Consulting | 22 |













1 Safety Precautions

1.1 General Safety





The series rechargeable battery is well designed and tested to meet all applicable states and international safety standards. However, like all electrical and electronic equipment, safety precautions must be observed and followed during the installation of the rechargeable battery to reduce the risk of personal injury and to ensure a safe installation.

Before installing the device, carefully read, fully understand and strictly follow the detailed instruction of the User Manual and other related regulations. And the safety instructions in this document are only supplements to local laws and regulations.

Li-PRO shall not be liable for any consequences caused by the violation of the storage, transportation, installation, and operation regulations specified in this document, including, but not limited to:

-  *Rechargeable battery damage due to force majeure, such as earthquake, flooding, thunderstorm, lighting, fire hazard, volcanic eruption, overvoltage, etc.*
-  *Rechargeable battery damage due to man-made cause*
-  *Rechargeable battery used or operated against any items in local policy*
-  *Failure to follow the operation instructions and safety precautions on the product and in this document*
-  *Installation and use under improper environment or electrical condition*
-  *Unauthorized modifications to the product or software*
-  *Rechargeable battery damage caused during transportation by the customer*
-  *Storage conditions that do not meet the requirements specified in this document*
-  *Failure to adequately maintain the equipment. An on-site inspection should be carried out by a qualified technician after 120 months of continuous use. If more than 120 months have been passed since the date of commissioning, or the user cannot prove that the equipment has been adequately maintained*
-  *Use of incompatible inverters or devices*
-  *Installation and commissioning operated by unauthorized personnel who are not licensed and /or satisfy state and local jurisdiction regulations.*

1.2 General Safety Precautions

-  *Overvoltage or wrong wiring may damage the battery pack and cause combustion which may be extremely dangerous.*
-  *Leakage of electrolytes or flammable gas may be occurred due to any type of product breakdown.*
-  *Do not install the battery pack in places where flammable and combustible materials are stored, and in which an explosive atmosphere is present.*
-  *The battery pack wiring must be carried out by qualified personnel.*



- ✚ *Battery pack must be serviced by qualified personal.*
- ✚ *Ensure that the grounding cable is connected before handling the battery pack.*

1.3 Battery Handling Guide

DO THINGS:

- ✚ *DO keep the battery pack away from flammables materials, heat sources, and water sources.*
- ✚ *DO keep the battery pack out of reach of children and animals.*
- ✚ *DO practice proper battery storage by keeping the battery pack in a clean environment, free of dust, dirt and debris.*
- ✚ *DO store the battery pack in a cool and dry place.*
- ✚ *DO seal the outer cable connection hole to prevent ingress of foreign objects.*
- ✚ *DO confirm that the wiring of the device must be correct.*
- ✚ *DO install the device according to the local standards and regulations.*

DON'T DO THINGS:

- ✚ *DON'T expose the battery pack to an open flame, or the temperature more than 140°F/60°C.*
- ✚ *DON'T store or install the battery pack in direct sunlight.*
- ✚ *DON'T install or operate the battery pack in places where there is excessive moisture or liquids.*
- ✚ *DON'T place the battery pack in a high voltage environment.*
- ✚ *DON'T disconnect, disassemble or repair the device by unqualified personnel. Only a qualified personnel is allowed to handle, install and repair the device.*
- ✚ *DON'T damage the device by dropping, deforming, impacting, cutting or penetrating with a sharp object. Otherwise, it may cause a fire or leakage of 3 Safety electrolytes; DON'T touch the device if liquid spill on it. There is a risk of electric shock.*
- ✚ *DON'T step on the packaging or the device may be damaged.*
- ✚ *DON'T place any objects on top of the battery pack.*
- ✚ *DON'T charge or discharge a damaged battery pack.*
- ✚ *DON'T dispose of the battery pack in a fire. It may cause leakage or rupture.*
- ✚ *DON'T mix different types or makes of the battery pack. It may cause leakage or rupture, resulting in personal injury or property damage.*



! WARNING!

- Do not crush or impact battery, and always dispose of it according to relevant safety regulations.
- The battery pack may catch fire when heated above 150°C/302°F.
- In case of catching fire, the battery pack will produce noxious and poisonous gases, and please keep away the battery.
- Damaged batteries may leak electrolyte or produce flammable gas. If users suspect that the battery is damaged, please immediately contact SolaX for advice and information.
- All operations of T-BAT-SYS-LD relating to electrical connection and installation must be carried out by qualified personnel.

! CAUTION!

- If the battery pack is not installed within a month after receipt, it must be charged for maintenance. Non-operational batteries should be discarded according to the local regulations.

2 System Application Introduction

This product is a household energy storage battery pack. The system is composed of a 5.1kwh/10.5kwh lithium iron phosphate battery pack.

This product can be used in conjunction with electricity, so that electricity consumption can be adjusted.

This product supports a variety of application modes, such as PV self-use surplus power to grid, peak shaving and valley filling, standby power supply, etc. The specific operation logic is as follows.

2.1 PV Self-use Surplus Power to Grid

Under the condition of good illumination in the daytime, the DC power from PV panel is changed into AC through inverter to supply power for household load. If the household load cannot run out of photovoltaic power, the remaining power will be stored in the battery. If the battery is full, photovoltaic power will be supplied to the grid. In the night or rainy days, photovoltaic cannot generate electricity. The battery supplies power to the home load through an inverter. If the battery SOC is low, the household load will take power from the grid.

2.2 Peak Shaving and Valley Filling

In some countries and regions where peak valley time of use price is implemented, if the difference between peak price and low price is large, the application mode of peak shaving and valley filling can be adopted in energy storage system. In the low electricity price period, the energy storage system is charged, in the peak period of electricity price, the energy storage system supplies power to the household load. It can avoid users using too much power grid when the electricity price is high and save energy expenditure.

2.3 Standby Power Supply

In some extreme weather (such as tornadoes, typhoons, hail), or substation operation failure, power supply



will be interrupted. If the energy storage system is installed, the user can still enjoy sufficient power guarantee under this situation.

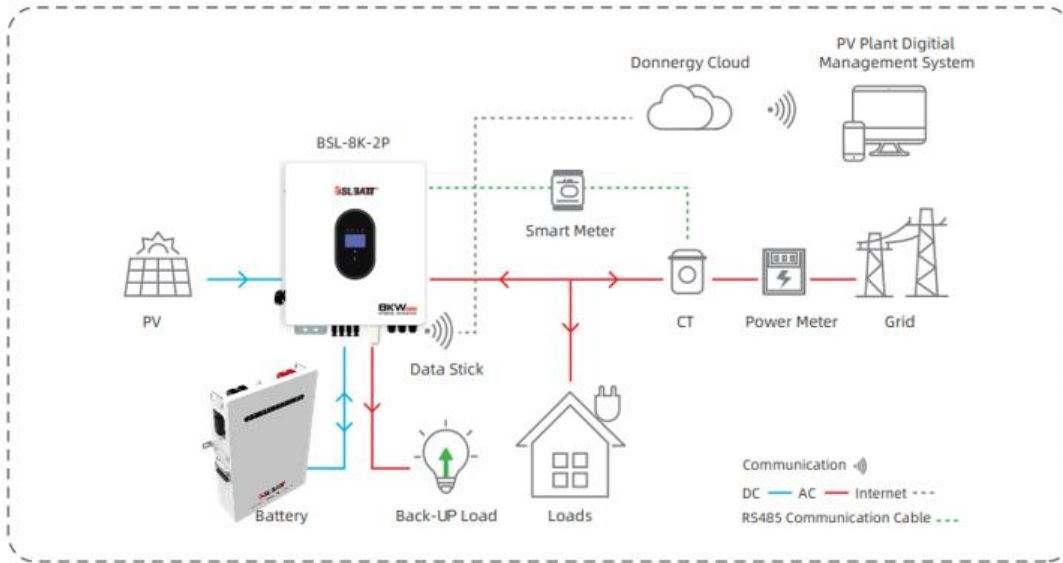

Figure 1. System Connection Diagram

3 Product Specification

3.1 System Description

The battery system consists of one or more rechargeable batteries. A battery pack is a type of electrical battery which can charge or discharge loads. There are two installation options, such as floor mounting and wall mounting, that a user can select from.

3.2 Appearance, Weight and Dimensions

Appearance:

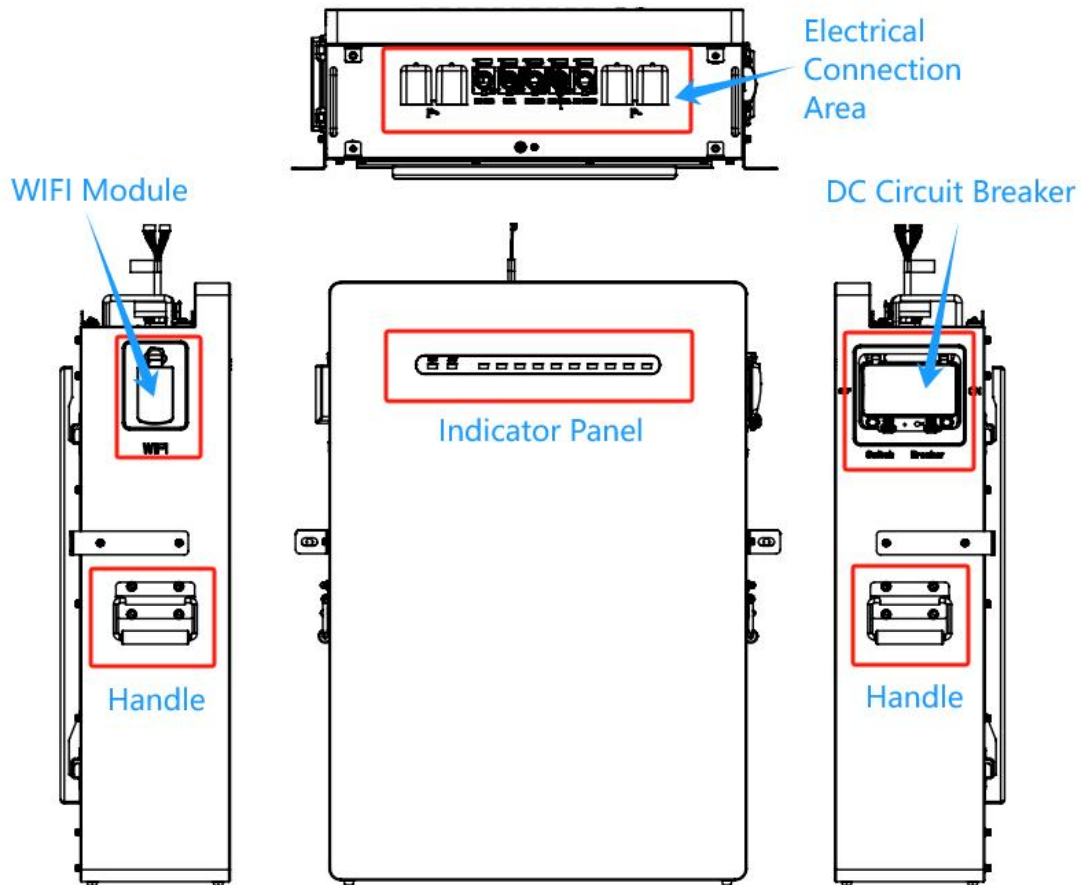

Table 2-1 Description of appearance

| N | Item | Description |
|---|----------------------------|--------------------------------------------------------------------------------------------------------------------------------------|
| 1 | Electrical connection area | Including BAT+/BAT- ports, communication port, BMS port. Please refer to “Electrical Connection Area” for details. |
| 2 | Indicator panel | Provide a human-readable indication of an instrument signal. For details, please refer to “Indicator Panel”. |
| 3 | DC Circuit Breaker | Including an air switch for automatically protection when current over limitation and a metal switch for power on the BMS. |
| 4 | Wi-Fi Module | Configure WIFI password to battery by phone Bluetooth and can monitor details and configure parameters of battery by cloud platform. |
| 5 | Handle | Lift the battery conveniently. |

Weight and Dimensions:

Table 2-2 Weight and dimensions of a battery pack

| N | Model | Li-PRO 5120 | Li-PRO 10547 |
|---|----------------|-------------|--------------|
| 1 | Length(mm) | 450 | 530 |
| 2 | Width(mm) | 171.5 | 215.5 |
| 3 | Height(mm) | 660 | 760 |
| 4 | Net weight(kg) | 53 | 95 |



3.3 Battery Parameters

| N | Item | Li-PRO 5120 | Li-PRO 10547 |
|----------------------------------------------------------------------------|----------------------------------|------------------------------|--------------|
| 1 | Nominal Voltage | 51.2V | |
| 2 | Rated Capacity (Ah) | 100 | 206 |
| 3 | Cell Model (LFP-3.2V) | 100Ah | 206Ah |
| 4 | Pack configuration | 16S1P | 16S1P |
| 5 | Rate power (Wh) | 5120 | 10547 |
| 6 | Charging Voltage | 55V | |
| 7 | Float charge Voltage | 54.5V | |
| 8 | Discharge Cut-off Voltage | 47V | |
| 9 | Recommended Charge Current | 50A | 100A |
| 10 | Recommended Discharge Current | 50A | 100A |
| 11 | Max Continuous Charge Current | 80A | 160A |
| 12 | Max Continuous Discharge Current | 100A | 200A |
| 13 | Pack Weight (Kg) | 53 | 95 |
| 14 | Internal Impedance | ≤100mΩ | |
| 15 | Communication protocol | CAN (500Kb/s)/RS485(9600b/S) | |
| 16 | Host software and Communication | RS232 | |
| 17 | Operation Temperature Range | Charge:0~55°C | |
| | | Discharge: -20~60°C | |
| 18 | Storage Temperature | -10°C~40°C | |
| Note: Parameters can be adjusted according to customer requirements | | | |

3.4 Packing List

| | | |
|-------------|-------------------------------------|---------------|
| System Pack | Communication line and output cable | user's manual |
|-------------|-------------------------------------|---------------|



3.5 System Drawing

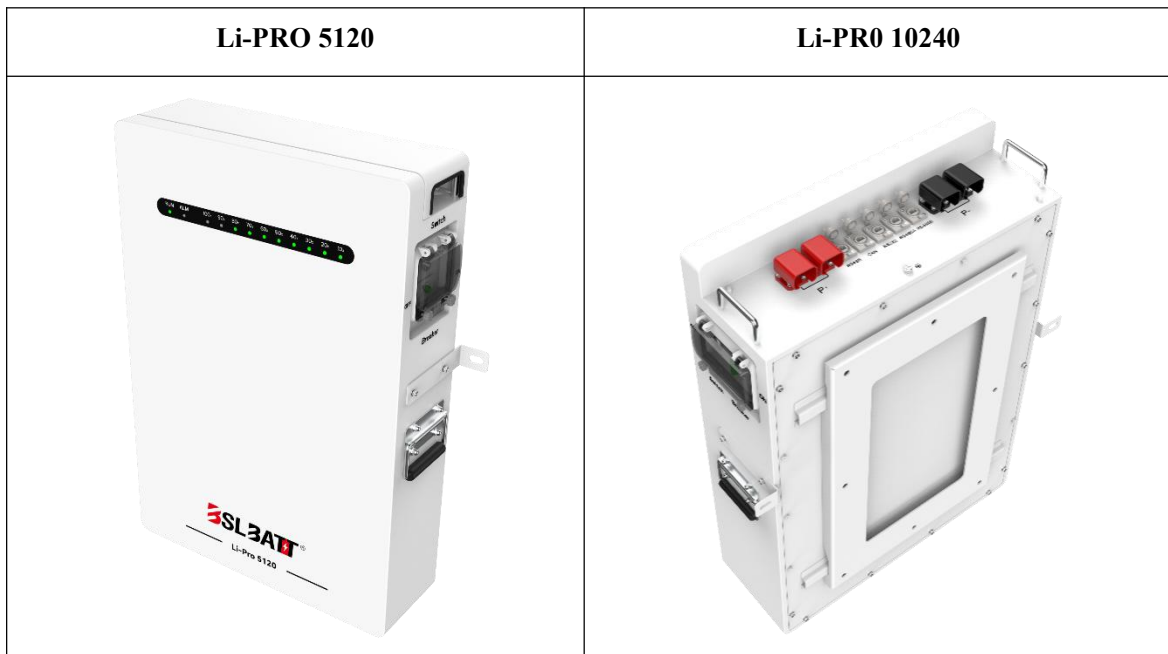

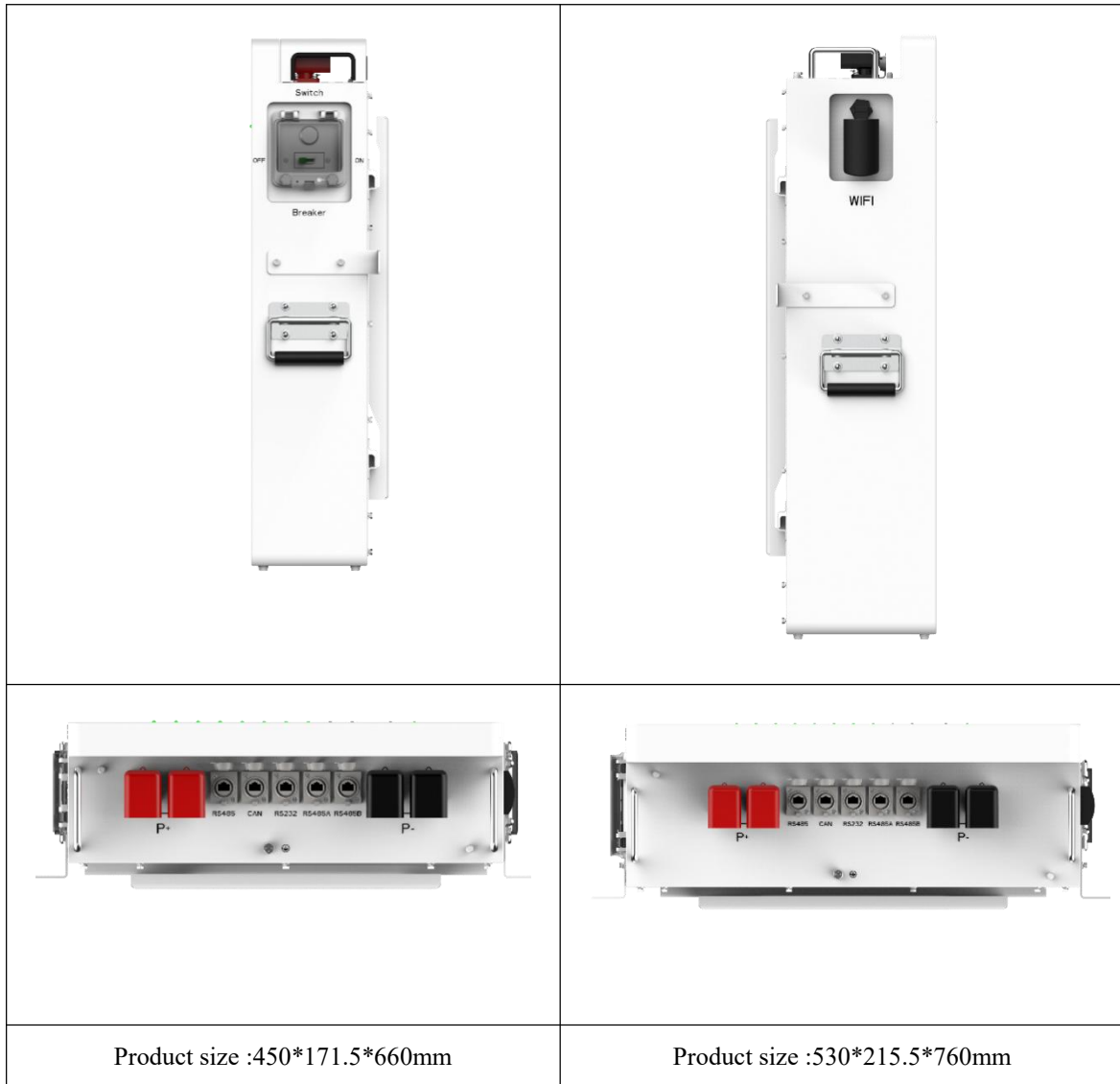

3.6 Interface Description

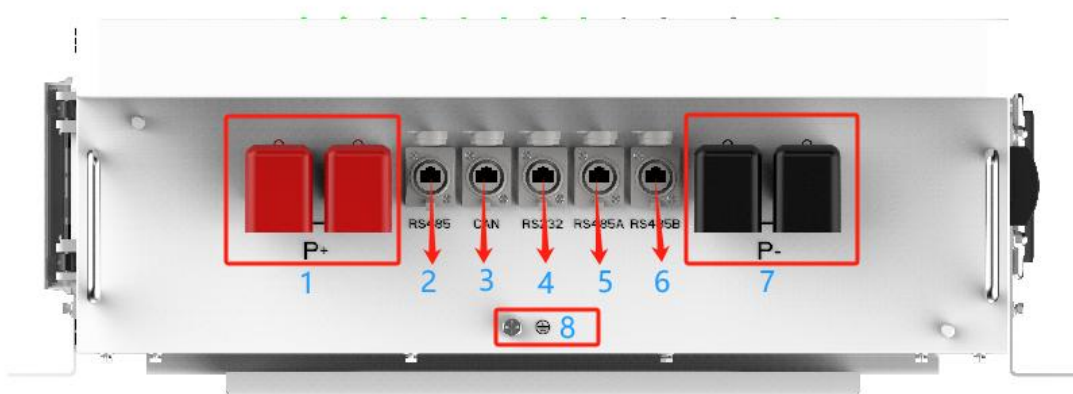
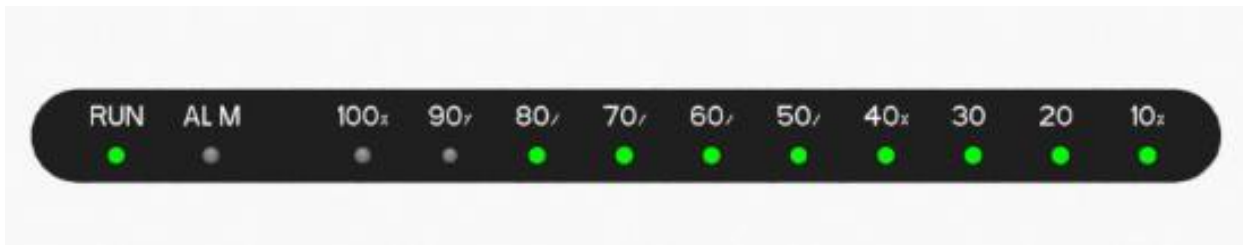

Figure 2
Table1.Battery Pack Front Panel Port Definition



| No. | Illustration | Silk-screen | Remark |
|-----|-----------------------|-------------|--------------------------------------------|
| 1 | Battery positive post | P+ | positive output |
| 2 | RS485 Port | RS485 | RS485 communication with PCS |
| 3 | CAN bus port | CAN | CAN bus and inverter connection ports |
| 4 | RS232 port | RS232 | communication port for computer monitoring |
| 5 | RS485A port | RS485A | battery paralleling communication port |
| 6 | RS485B port | RS485B | battery paralleling communication port |
| 7 | Battery negative post | P- | negative output |

3.7 LED Display Definition



| Run-Led | Alarm-Led | Led-10 | Led-9 | Led-8 | Led-7 | Led-6 | Led-5 | Led-4 | Led-3 | Led-2 | Led-1 |
|------------|------------|--------------------------|-------|-------|-------|-------|-------|-------|-------|-------|-------|
| RUN | ALM | Capacity indicator light | | | | | | | | | |
| | | 100% | 90% | 80% | 70% | 60% | 50% | 40% | 30% | 20% | 10% |

Table 2 LED Working Status Indicators

| Status | Normal/Alarm /Protection | RUN | ALM | Electricity indicator LED | | | | | | | | | |
|-----------|--------------------------|---------|--------|-----------------------------------------------------------------------------------------------|-----|-----|-----|-----|-----|-----|-----|-----|-----|
| | | ●/● | ●/● | ●/● | ●/● | ●/● | ●/● | ●/● | ●/● | ●/● | ●/● | ●/● | ●/● |
| Power off | Dormancy or Undervoltage | off | off | off | off | off | off | off | off | off | off | off | off |
| Standby | Normal | ●Bright | off | According to the electricity indicator | | | | | | | | | |
| | Alarm or SOC<20% | ●Bright | ●Flash | | | | | | | | | | |
| Charge | Normal | ●Flash | off | ●Turning blue According to the electricity indicator (Remaining SOC LED flowing affect) | | | | | | | | | |
| | Alarm | ●Flash | ●Flash | | | | | | | | | | |
| | Protection | ●Flash | ●Flash | | | | | | | | | | |
| Discharge | Normal | ●Flash | off | ●Turning green | | | | | | | | | |



| | | | | | | | | | | | | | | |
|---------|------------|---------|----------|---------------------------------------------------------------------------|-----|-----|-----|-----|-----|-----|-----|-----|-----|-----|
| | Alarm | ● Flash | ● Flash | According to the electricity indicator (Flashing once every 2 seconds) | | | | | | | | | | |
| | Protection | ● Flash | ● Flash | | | | | | | | | | | |
| Invalid | Normal | off | ● Bright | off | off | off | off | off | off | off | off | off | off | off |

4 Preparation before Installation

4.1 Selection of Installation Location

The installation location selected for the rechargeable battery is quite critical in the aspect of the guarantee of machine safety, service life and performance.

- ✚ It has the IP65 ingress protection, which allows it to be installed outdoor.
- ✚ Before installing the battery system, lay out available floor space or wall space including aisles for installation, maintenance and possible battery pack replacement.

4.2 Environment Requirement

Make sure the installation site meets the following conditions:

- ✚ The operating temperature: -20°C to +53°C.
- ✚ The humidity shall be between 5-95%.
- ✚ Do not install the rechargeable battery in the areas where the altitude exceeds 3000 m.
- ✚ Install the rechargeable battery in a well-ventilated environment for heat dissipation.
- ✚ Do not install the rechargeable battery in areas with flammable, explosive and corrosive materials.
- ✚ Do not install the rechargeable battery in areas near combustibles and antenna.
- ✚ You are recommended to install an awning over it. Direct sunlight, rain exposure and snow laying. up is not allowed.

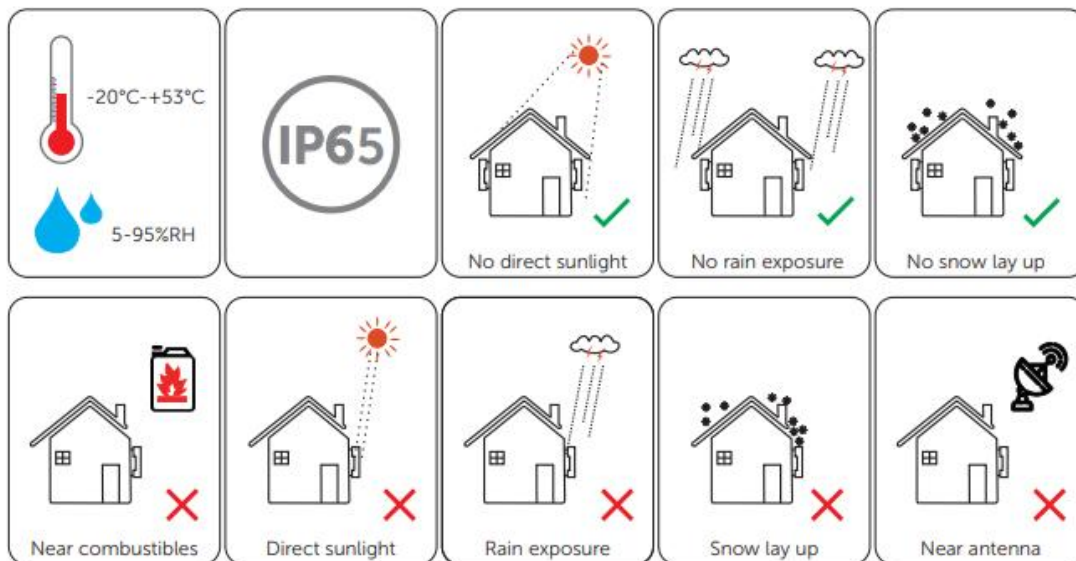



Insulated glove



Safety goggles



Safety shoes

4.3 Installation Carrier Requirement

The mounting location must be suitable for the weight and dimensions of the product and the support surface for installation must be made of a non-flammable material:

- ✚ Solid brick/concrete.
- ✚ Either floor mounting or wall mounting, the bearing capacity of the area to place or install a battery pack must be over 200 kg.
- ✚ Please ensure that the thickness of any part of the wall should not be less than 100 mm.
- ✚ The device must not be installed on the wood wall.

4.4 Clearance Requirement

To guarantee proper heat dissipation and ease of disassembly, the minimum space around the rechargeable battery must meet the standards indicated below:

- ✚ No matter which floor mounting or wall mounting is chosen, a distance between 200 and 300 mm wide shall be provided from the wall to the edge of the battery pack.
- ✚ No matter which floor mounting or wall mounting is chosen, a distance between 400 and 600 mm wide shall be provided from the left side edge of a battery pack to the right-side edge of the neighboring battery packs.
- ✚ In the case of floor mounting, 55 mm shall be provided from the rear side of the battery pack to the wall.
- ✚ In the case of wall mounting, the distance between 300 and 350 mm shall be provided from the grounding to the bottom of the battery pack.

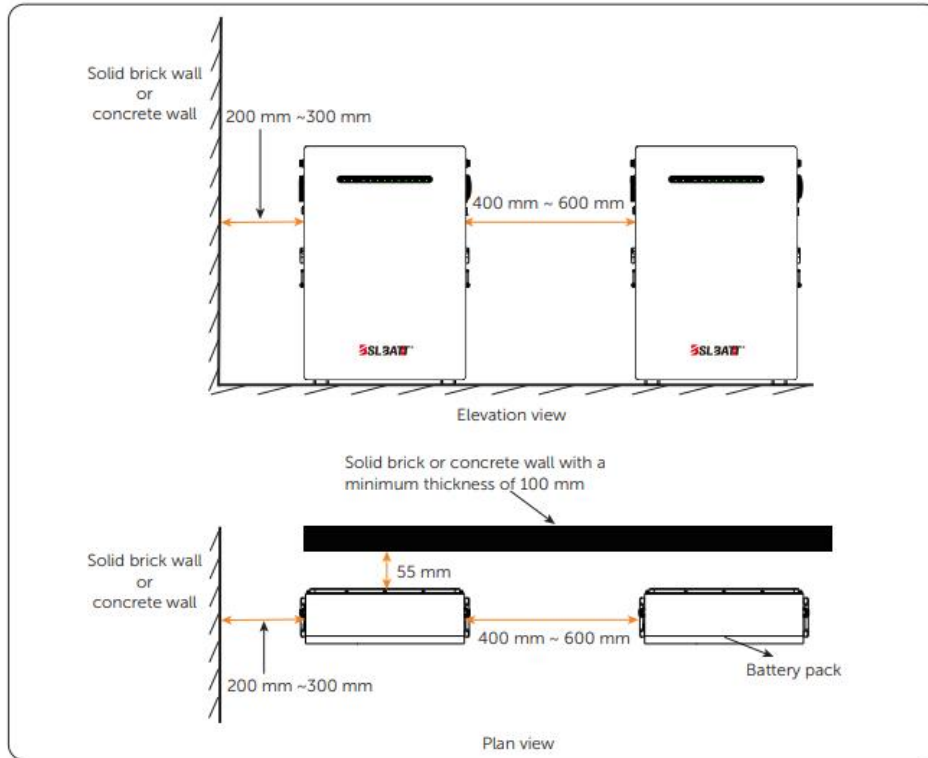

Figure: Clearance requirement about floor mounting

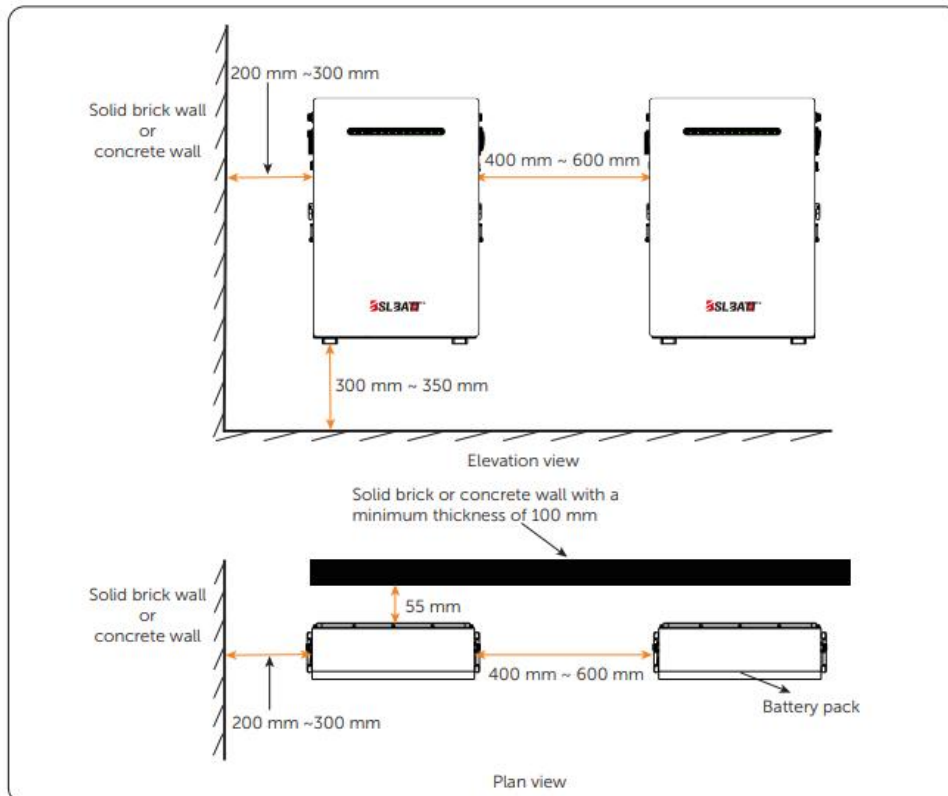

Figure: Clearance requirement about wall mounting

4.5 Tools Requirement

Installation tools include but are not limited to the following recommended ones. If



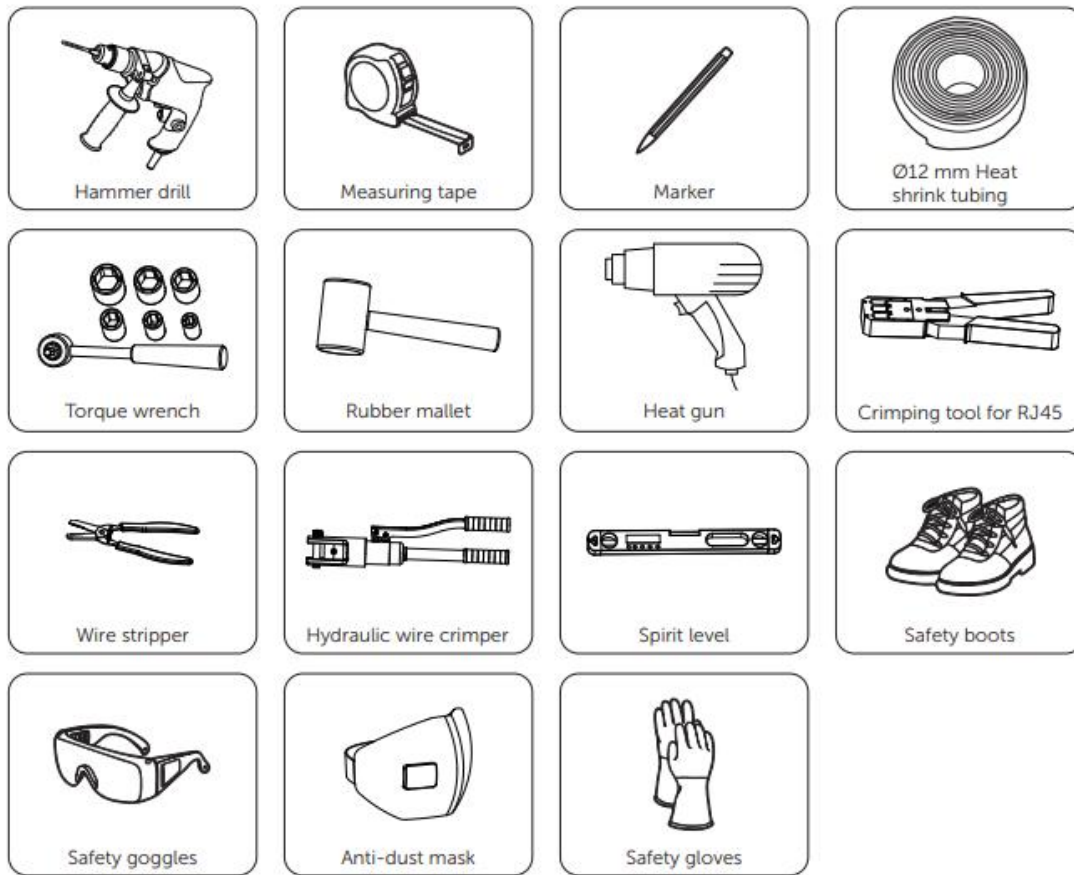

necessary, use other auxiliary tools on site.



4.6 Installation steps

Unpacking:

-  The rechargeable battery undergoes 100% testing and inspection before shipping from the manufacturing facility. However, transport damage may still occur. Before unpacking the rechargeable battery, please verify that the model and outer packing materials for damage, such as holes and cracks.
-  Unpacking the battery pack according to the following figures. If there are other cartons, such as the rack carton, cabinet carton, cables carton, or cartons about wall mounting, the unpacking procedure can also be referred to the following figures.

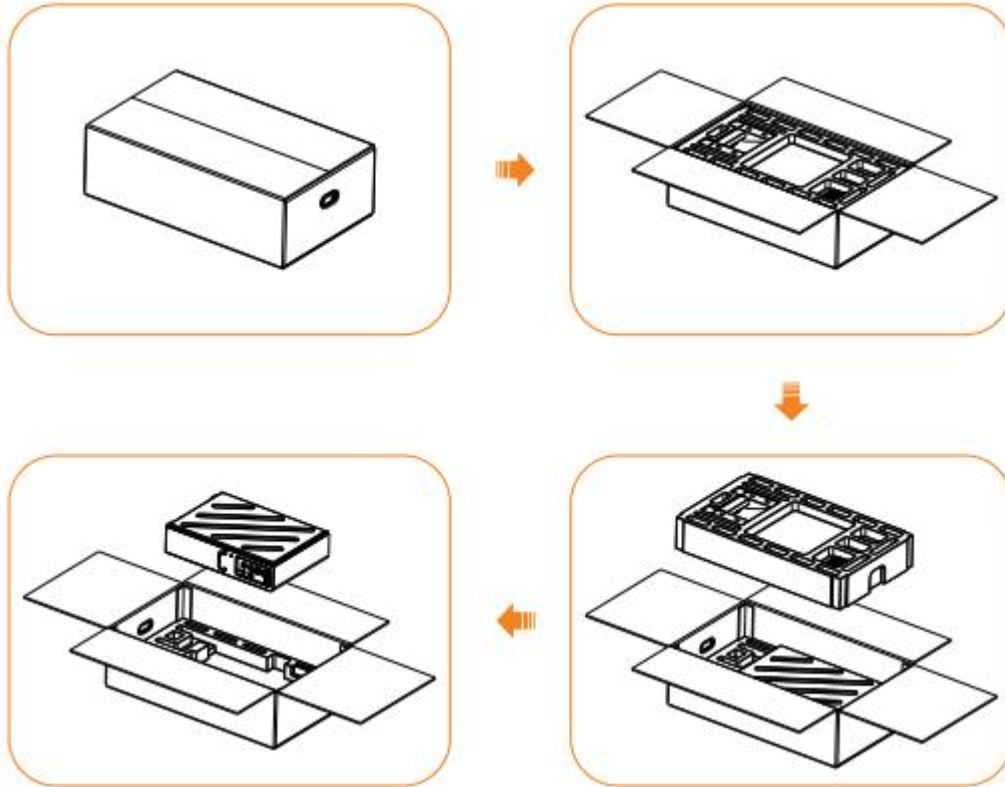

Figure: Unpacking the battery pack

- ✚ Be careful when dealing with all package materials which may be reused for storage and relocation of the rechargeable battery in the future.
- ✚ Upon opening the package, check whether the appearance of the rechargeable battery is damaged or lack of accessories. If any damage is found or any parts are missing, contact your dealer immediately.

4.7 Installation Options

There are two installation options (floor mounting and wall mounting) are available, with details as follows:



Option A: Floor Mounting

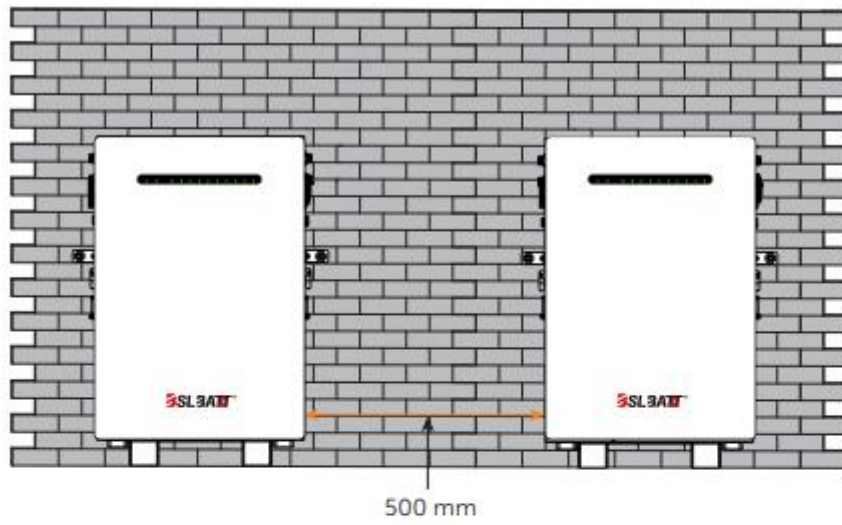

Option B: Wall Mounting

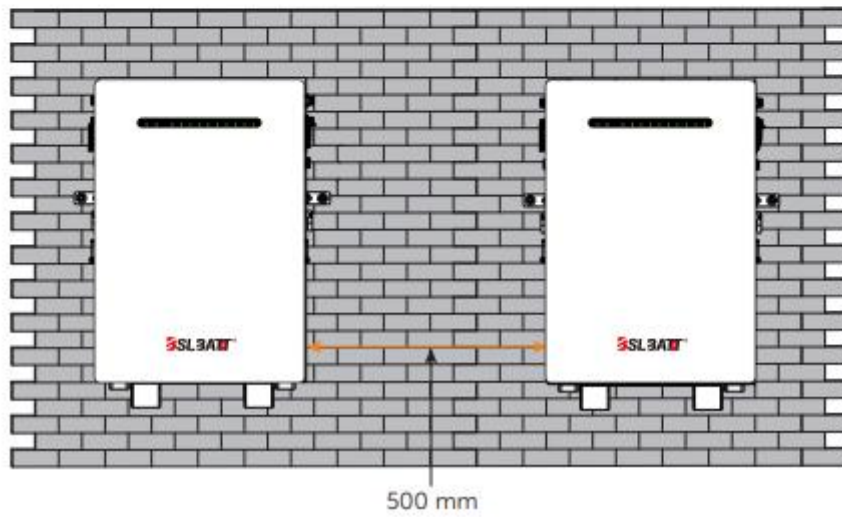

Figure: Installation options



4.8 Installation Procedure

⚠ WARNING!

- Only the qualified personnel can perform the mechanical installation following the local standards and requirements.
- Check the existing power cables or other piping in the wall to prevent electric shock or other damage.
- The bi-directional energy storage inverter connected with the battery pack must be an isolated inverter.

⚠ CAUTION!

- Always be aware of the weight of the battery. Personal injuries may result if the battery is lifted improperly or dropped while being transported or mounted.
- Be sure you have all the proper protective clothing, safety tools, and equipment on hand before starting the installation.
- Keep the work area clean and well lit. Cluttered or dark areas invite accidents.

Note: when a single unit is used, the inverter uses the battery as the main machine to communicate; when multiple batteries are used in parallel, the batteries inside are connected in parallel through the RS485B hardware interface, RS485A/CANBUS communicates with the inverter.

5 Appendix1

When the equipment manufacturer confirms that it is necessary, it can authorize to provide the customer with the host software and operating instructions.



Figure 7 RS232 Serial port communication device

Host soft operation:

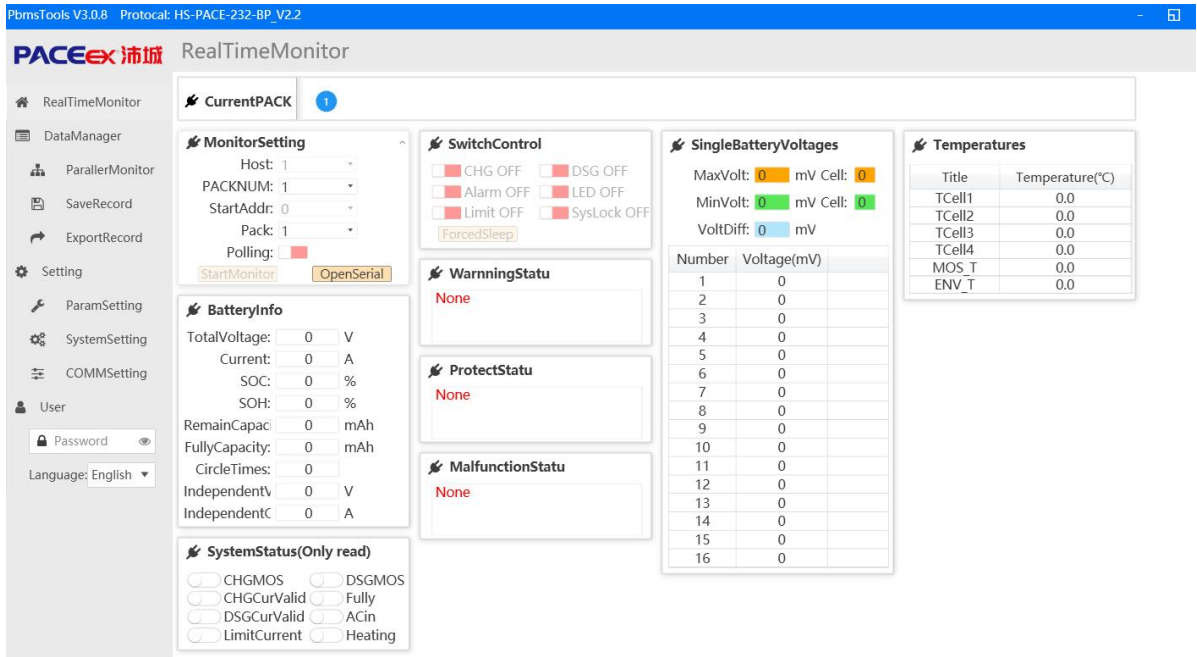















Figure 8

6 Appendix2

Multi Inverter protocol support:

| NO | Type | Inverter | Protocol |
|----|------|--------------|-------------------------------------------------------------------------------------------------------------------------------------------------|
| 1 | CAN | Pylon |  PYLONTECH PYLON CAN LV V1.3-2019.03.01 |
| 2 | | DEYE/Sunsynk |  Deye 德業® PYLON CAN LV V1.3-2019.03.01 |
| 3 | | Growatt |  GROWATT 古瑞瓦特 Growatt CAN LV V1.09-2020.10.22 |
| 4 | | Victron |  victron energy BLUE POWER Victron CAN 2021.01.07 |
| 5 | | Luxpower |  LUX POWER ^{TEK} Luxpowertek CAN V1.0-2020.02.11 |
| 6 | | SMA |  SMA SMA CAN V2.0 |
| 7 | | Goodwe |  GOODWE 固德威 GoodWe CAN Inverter LV V1.7-2020.02.28 |



| | | | |
|----|---------------|-------------------------------------------------------------------------------------|-------------------------------------------|
| 8 | Studer |  | STUDER CAN V1.02-2018.06.14 |
| 9 | Sofar |  | SofarSolar CAN inverter V6 |
| 10 | Ginlong/Solis |  | GINLONG CAN LV V1.0-2019.12.28 |
| 11 | TBB_LITHIUM |  | TBB CAN V1.05-2021.04.20 |
| | | | TBB CAN V1.1-2021.10.21 |
| 12 | Daneng |  | DANENG CAN V10-2022.10.10 |
| 13 | Aiswei |  | AISWEI CAN V1.0 |
| 14 | SAJ |  | SAJ CAN V1.9-2022.06.30 |
| 15 | MUST |  | MUST CAN V2.0.2-2021.06.02 |
| 16 | Megarevo |  | PYLON CAN LV V1.3-2019.03.01 |
| 17 | Afore |  | Afore CAN Hybrid Inverter V2.2-2023.06.02 |

| | | | | |
|---|-------|--------------|-------------------------------------------------------------------------------------|--------------------------------------------|
| 1 | RS485 | Pylon |  | PYLON RS485 LV-BPB V3.5-2019.08.07 |
| 2 | | DEYE/Sunsynk |  | PYLON RS485 LV-BPB V3.5-2019.08.07 |
| 3 | | Growatt |  | Growatt RS485 V2.01-2019.02.13 |
| 4 | | Voltronic |  | Voltronic RS485 Inverter V1.0-2018.09.11 |
| 5 | | Phocos |  | Phocos RS485 2021.04.07 |
| 6 | | Luxpower |  | Luxpowertek RS485 inverter V0.3-2020.07.06 |



| | | | |
|----|---------|-----------------------------------------------------------------------------------|----------------------------------------------|
| 7 | WOW |  | WOW RS485 Modbus V1.3-2017.06.27 |
| 8 | Sorotec |  | Sorotec RS485 Inverter V1.22-2017.11.28 |
| 9 | Hypon |  | HYPONTECH RS485 Modbus V2.0-2023.06.29 |
| 10 | Afore |  | Afore RS485 Hybrid Inverter V1.02-2022.03.07 |

Default setting: CANBUS - Victron, RS485-DEYE.

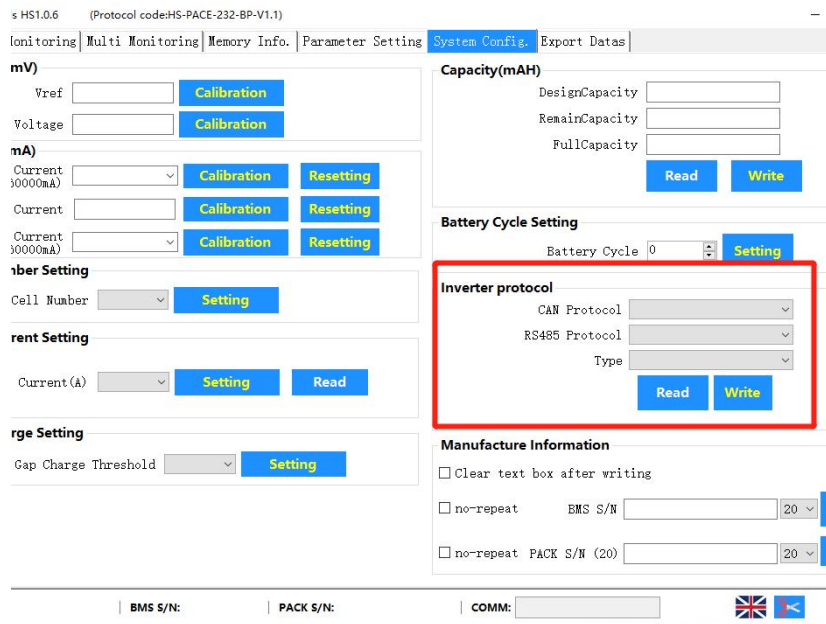

Remark:

- Please ask your sales team to provide password for host computer software administration enter.
- Different inverters the pin assignment is not the same, please contact inverter supplier for detailed RJ45 cables of pin assignment.

Connector pin configurations for the above-mentioned inverter manufacturers are listed below:

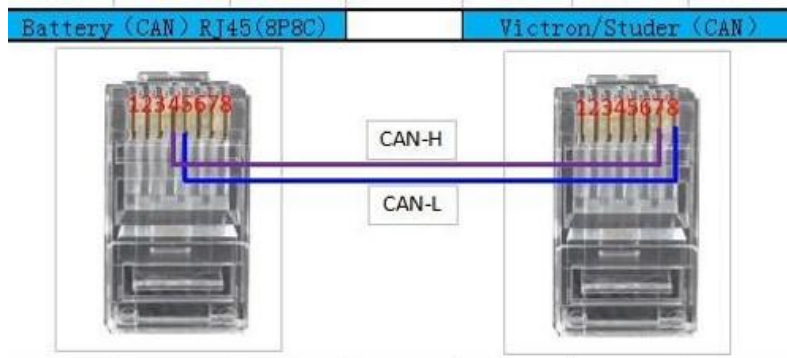

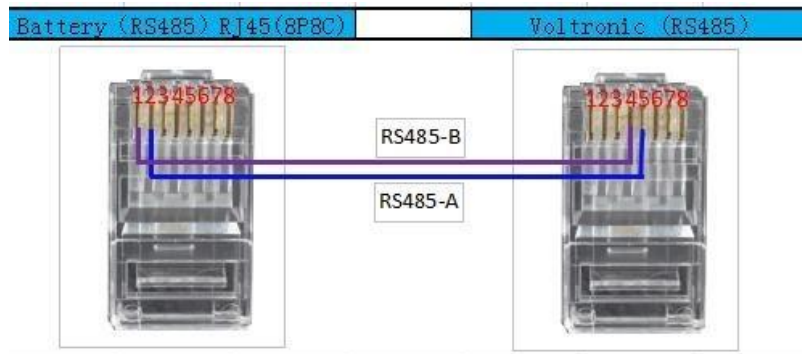
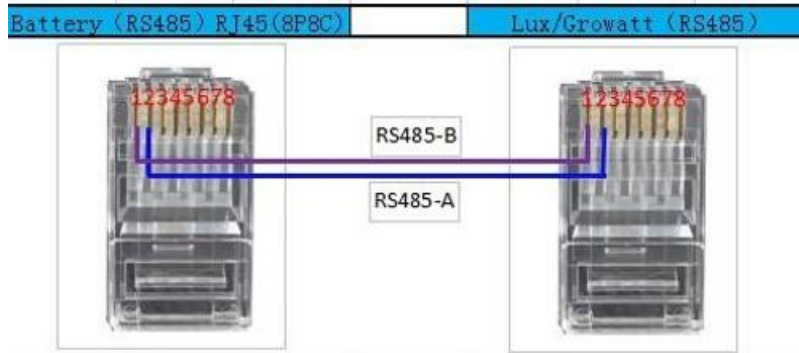
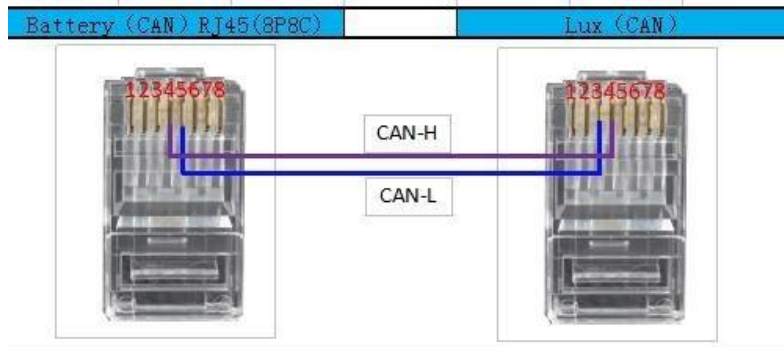
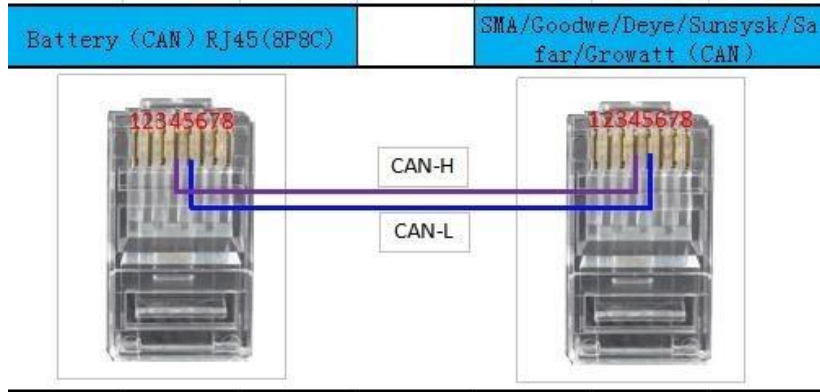

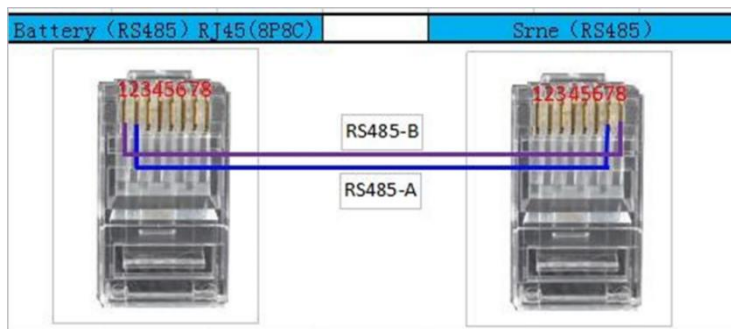

7 Appendix3

7.1 Abnormal Situation Addressing

1. What if the battery pack does not work properly after power on?

A: The most direct way is to connect to the upper computer, through the upper computer to find the fault phenomenon, causes can be roughly analyzed from the upper computer interface prompt alarm, protection, fault, and other information, it can also provide necessary reference for further testing.

2. Under what circumstances will RS232 communication fail?

A: The following steps can be taken to eliminate the problem:

- 1) Confirm that at least one of the indicator lights of the battery pack is on or flashing, that is, the battery pack is in normal working condition.
- 2) Confirm that the host computer software selects correct COM port (view device manager);
- 3) Confirm whether the RS232 communication line is fully inserted into the corresponding communication interface of the battery pack.

3. Under what circumstances will RS485 fail to parallel batteries communication?

A: The possibility of failure of parallel batteries communication is as follows: first ensure whether the parallel RS485 communication port has been connected, and then make sure that the address dialing position of the battery pack is correct, and make sure that the RS485 terminal Plug-in in the right place.

4. What is the fault alarm mechanism?

A: battery pack has fault alarm function, can be checked through upper computer software.

Failure includes:

- 1) Sampling failure: analog front-end and main control chip communication failure. When the fault occurs, the charge and discharge function is turned off, and the fault alarm can be automatically cleared after the fault is cleared.
- 2) Temperature NTC failure mainly detects whether the temperature NTC is short-circuited or disconnected. When the fault occurs, the charge and discharge function is turned off, and the fault alarm can be automatically cleared after the fault is cleared.
- 3) Cell failure: the voltage difference of the cell exceeds 1V, or the difference between the total voltage detection voltage and the sum of single cell voltage is more than 5V, or the minimum voltage is less than 0.5V. The voltage sampling line disconnect also reports the same fault. When the fault is cleared, the fault



alarm can be automatically cleared.

After the battery is connected to the system and shows over-current protection or short circuit protection. This is not a problem with the battery pack, but the capacity load of the electrical equipment is too large. Charging can remove the alarm or extend the battery pack pre-charge circuit delay time.

7.2 Product Responsibilities and Consulting

We will not be liable for the accidents resulting from operation breaking this specification and user manual.

We will not send separate notice, provided that the contents of this specification are changed due to improvement of product quality or technological upgrading, if you want to understand the latest information of this product, please contact us.

The shelf life of this product is within 60 months after it is delivered; we will maintain the product, which is in the warranty period for free of charge, if it has any product quality problems within the specified operation range, we may replace the relevant parts, if we fail to maintain it,

To achieve the purpose of sustainable use without performance reduction; our after-sales service personnel will propose the specific maintenance and troubleshooting methods.

In case of any questions, please contact us.

| WARRANTY CARD | | | |
|----------------------------------------------------------------------------------------------------------------------------------------------------------------------------------------------------------------------------------------------------------------------------------------------------------------------------------------------------------------------------------------------------------------------------------------------------------------------------------------------------------------------------------------------------------------------------------------------------------------------------------------------------------------------------------------------------------------------------------------|--|---------------|--|
| Product Name | | Model Number | |
| BATCH NO. | | Shipping Date | |
| The Buyer | | Phone | |
| Address | | | |
| <p>If a device becomes defective during the agreed warranty period, please report the defective device situation to the original manufacturer with this warranty card. Supplier or end users required to send the warranty claim form to the original manufacturer or authorized service partner with all the necessary information. Customers must present this warranty card, battery purchasing invoice, extension warranty letter if applicable, and other related materials as well if required. It is the responsibility of the warranty holder to substantiate the warranty claim and show that the conditions are met. Please note the original manufacturer reserve the ultimate explanation right on this warranty card.</p> | | | |

THANK YOU FOR CHOOSING
LET'S DEVELOP TRUST AND BUSINESS



BSLBATT[®]

Best Solution Lithium Battery

Since 2003, BSLBATT provides electric energy more efficiently and reliably as best solution. Powerwall charges by day and powers at night for residential solar system with compact, affordable, and easy installation features.

BSLBATT Battery - Solar

inquiry@bsl-battery.com

+86-752 2819 469



Building 1, Zhongkai Innovation Base of Lihe Science and Technology, Huizhou, Huizhou City,
Guangdong Province, China