

# Powerwall Battery

## User Manual

**BSLBATT®**

*Best Solution Lithium Battery*

**Model No: B-LFP48-200PW**



**Product Name:51.2V 200Ah Powerwall Battery**

**V1.0**

# CONTENTS

1. Safety Precautions .....	1
1.1 Note Before Installation .....	1
1.2 During Operation .....	2
1.3 Post-installation maintenance .....	2
2. System Application Introduction .....	2
2.1 PV Self-use Surplus Power to Grid .....	2
2.2 Peak Shaving and Valley Filling .....	2
2.3 Standby Power Supply .....	3
3. Product Specification .....	4
3.1 Packing List .....	4
4. Battery Drawing .....	5
4.1 Interface Description .....	5
4.2 LED Display Definition .....	6
4.3 Battery Connection and Communication Instructions .....	8
4.4 Interface Diagram .....	11
4.5 Display rendering .....	11
5. Battery Installation Instructions .....	14
5.1 Installation location .....	14
5.2 Installation Tools .....	14
5.3 Installing battery strings .....	15
5.4 Installing battery striogs in parallel .....	17
6. Appendix1 .....	19
7. Appendix2 .....	20
8. Appendix3 .....	23

## 1. Safety Precautions

It is very important and necessary to read the user manual carefully before installing or using the battery. Failure to follow any of the instructions or warnings in this document can result in electrical shock, serious injury, or may damage the battery and the whole system.

The battery needs to be recharged within 12 hours after fully discharging.

Do not expose cable outside.

All battery terminals must be disconnected before maintenance.

Do not use cleaning solvents to clean the battery.







Do not expose the battery to flammable or harsh chemicals or vapors.

Do not connect battery with PV solar wiring directly.

Any foreign object is prohibited to be inserted into any part of the battery.

Any warranty claims are excluded for direct or indirect damage due to items above.

If the battery is stored for a prolonged time, it is requirement that they are charged every three months, and the SOC should be no less than 30%.

Symbol	Description
	Caution, risk of electric shock
	Heavy enough may cause severe injury
	Keep the battery away from open flame or ignition sources
	Keep the battery away from children
	Do not dispose of the product with household waste
	Recycling
	Read this manual before installation and operation

### 1.1 Note Before Installation

When receiving, please check the battery and packing list first, if the battery is damaged or spare parts are missing, please contact the dealer;

Before installation, be sure to cut off the grid power and make sure the battery is in the turned-off mode;

Wiring must be correct, do not mix-connect the positive and negative cables, and ensure no short circuit with the external device;

It is prohibited to connect the battery with AC power directly;

The embedded BMS in the battery is designed for 51.2 VDC, please do not connect battery in series;

It is prohibited to connect the battery with different type of battery;  
Please ensure the electrical parameters of battery system are compatible to inverter;  
Keep the battery away from fire or water.

### **1.2 During Operation**

If the battery system needs to be moved or repaired, the power must be cut off first and the battery is completely shutdown;

It is prohibited to connect the battery with different type of battery;

It is prohibited to put the batteries working with faulty or incompatible inverter;

In case of fire, only dry powder fire extinguisher can be used, liquid fire extinguishers are prohibited;

Please do not open, repair or disassemble the battery. We do not undertake any consequences or related responsibility due to violation of safety operation or violating of design, production and equipment safety standards.

### **1.3 Post installation maintenance:**

Temperature control: Ensure that the operating temperature of the battery string is within an appropriate range. Excessive temperature may degrade the battery string performance or even damage it. Avoid exposing the battery pack to extreme temperatures and ensure that there is good ventilation around the battery pack.

Cleaning and maintenance: Clean the battery pack regularly to remove dust, dirt or other impurities. Use a soft cloth or brush to gently wipe the battery pack housing. Do not touch the battery string with water or liquid. Otherwise, the battery may be shocked or damaged.

Periodic check: Periodically check whether battery string cables, plugs, and connectors are loose or corroded. If loosening or corrosion is found, repair or replace it in time.

Charge and discharge control: Follow the battery pack manufacturer's charge and discharge recommendations. Do not overdischarge or overcharge the battery pack to avoid adverse effects on its life and performance. Use the right charger and follow the correct charging method.

Safe operation: Pay attention to safe operation when using the battery string. Avoid strong vibration, impact, or intense pressure on the battery pack. If the battery pack appears abnormal, such as heat, leakage, or odor, discontinue use immediately and seek professional help.

## **2.System Application Introduction**

02

This product is a household energy storage battery pack. The system is matched with a 10kw lithium iron phosphate battery pack. This product can

be used in conjunction with electricity, so that electricity consumption can be adjusted. This product supports a variety of application modes, such as PV self-use surplus power to grid, peak shaving and valley filling, standby power supply, etc. The specific operation logic is as follows.

### 2.1 PV Self-use Surplus Power to Grid

Under the condition of good illumination in the daytime, the DC power from PV panel is changed into AC through inverter to supply power for household load. If the household load cannot run out of photovoltaic power, the remaining power will be stored in the battery. If the battery is full, photovoltaic power will be supplied to the grid. In the night or rainy days, photovoltaic cannot generate electricity. The battery supplies power to the home load through an inverter. If the battery SOC is low, the household load will take power from the grid.

### 2.2 Peak Shaving and Valley Filling

In some countries and regions where peak valley time of use price is implemented, if the difference between peak price and low price is large, the application mode of peak shaving and valley filling can be adopted in energy storage system. In the low electricity price period, the energy storage system is charged; in the peak period of electricity price, the energy storage system supplies power to the household load. It can avoid users using too much power grid when the electricity price is high, and save energy expenditure.

### 2.3 Standby Power Supply

In some extreme weather (such as tornadoes, typhoons, hail), or substation operation failure, power supply will be interrupted. If the energy storage system is installed, the user can still enjoy sufficient power guarantee under this situation. Figure 1

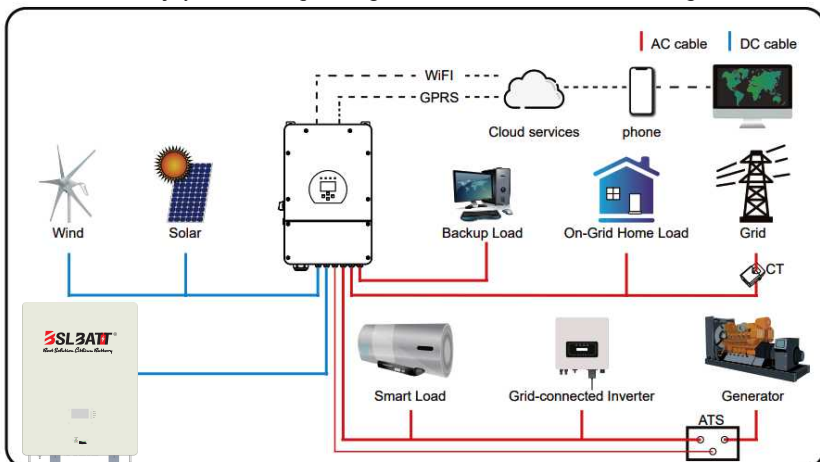





Figure 1. System Connection Diagram

### 3.Product Specification

No	Item	General Parameter
1	Nominal Voltage	51.2V
2	Rated Capacity(Ah)(typical)	200
3	Cell Model (LFP-3.2V)	100Ah
4	Pack configuration	16S2P
5	Rate power(Wh)	10240
6	Charging Voltage(V)	56.2V
7	Float charge Voltage(V)	55V
8	Discharge Cut-off Voltage(V)	43.2V
9	Charging Current limits(A)	190A
10	Max Discharging current(A)	200A
11	Charge over Current protect(A)	210/Adjustable
12	Discharge over Current protect(A)	210/Adjustable
13	Pack Weight	95kg
14	Internal Impedance	$\leq 100\text{m}\Omega$
15	Communication protocol	CAN(500Kb/s)/RS485(9600B/S)
16	Host software and Communication	RS232
17	Operation Temperature Range	Charge:0~55°C
		Discharge: -20~55°C
18	Storage Temperature	-20~55°C

Note: Parameters can be adjusted according to customer requirements (within limits of product certification), please contact BSL for instructions

#### 3.1Packing List

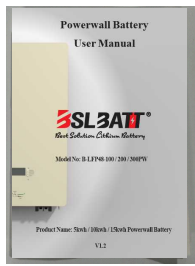
Battery pack	Output cable	Parallel communication line	users manual
			



4.1. Interface Description

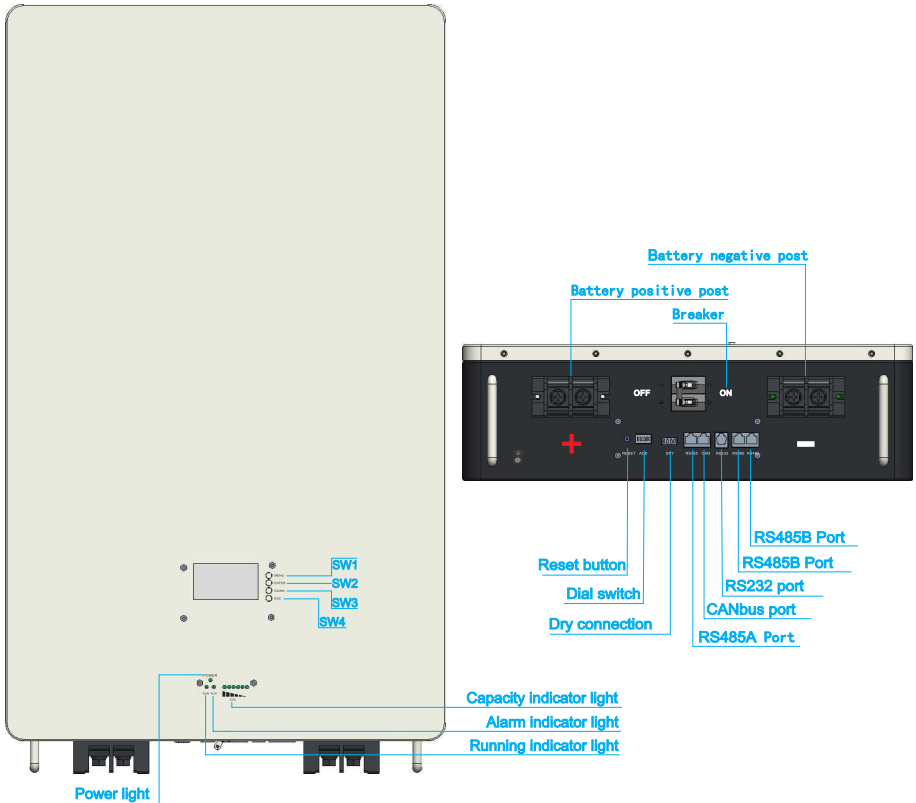
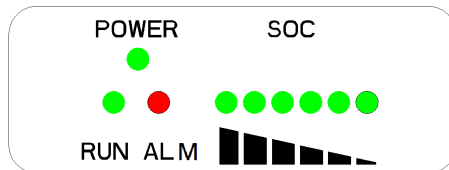

Figure2. Interface Definition Description

**Table1.Battery Pack Frontpanel Port Definition**

No.	Illustration	Silk-screen	Remark
1	Battery positive post	P+	positive output
2	Battery negative post	P-	negative output
3	Reset button	RESET	Reset battery
4	Dial switch	DIP	Address setting, range 2~15
5	Dry connection	DRY	pin3 to pin4 often open, closed with low power alarm Pin1 to pin2 often open, closed when failure or protection
6	RS485A Port	RS485	RS485 communication with monitoring equipment
7	CANbus port	CAN	CANbus and inverter connection ports
8	RS232 port	RS232	RS232 communication port
9	RS485B port	RS485	RS485 paralleling communication port
10	Power light	POWER	After startup, the LED is steady green
11	Running indicator light	RUN	After startup, the LED blinks green
12	Alarm indicator light	ALM	The fault is displayed in red
13	Capacity indicator light	SOC	Refer to Table 2
14	Breaker	ON/OFF	Battery string output is enabled

**4.2 LED Display Definition**



No.	Definition	Specification	Criteria
1	POWER Light	System no abnormal, always bright	
	RUN Light	See Table 2, Table 4	
	ALM Light	See Table 2, Table 4	
	SOC Light	See Table 3, Table 4	



**Table 2 LED Working Status Indicators**

Status	Normal/alarm /protection	RUN	ALM	Electricity indicator LED						Remark	
		●	●	●	●	●	●	●	●		
Power off	Dormancy	off	off	off	off	off	off	off	off	off	All off
Stand by	Normal	Flash 1	off	According to the electricity indicator						Standby status	
	Alarm	Flash 1	Flash 3							Module low voltage	
Charge	Normal	Bright	off	According to the electricity indicator (power indicator maximum LED flash 2)						Maximum power LED flash (flash 2), overcharge alarm ALM no flash	
	Alarm	Bright	Flash 3								
	Overcharge protection	Bright	off	Bright	Bright	Bright	Bright	Bright	Bright	If there is no electricity, the indicator is in standby status	
	Temperature, overcurrent, failure protection	off	Bright	off	off	off	off	off	off	off	Stop charging
Discharge	Normal	Flash 3	off	According to the electricity indicator							
	Alarm	Flash 3	Flash 3								
	Undervoltage protection	off	off	off	off	off	off	off	off	off	Stop discharging
	Temperature, overcurrent, short circuit, reverse connection, failure protection	off	off	off	off	off	off	off	off	off	top discharging
Invalid	Normal	off	off	off	off	off	off	off	off	off	Stop charge/discharging

**Table 3 Description of capacity indicators**

Status	Charge							Discharge					
	L6	L5	L4	L3	L2	L1	L6	L5	L4	L3	L2	L1	
Capacity indicator	●	●	●	●	●	●	●	●	●	●	●	●	
	0~16.6%	off	off	off	off	off	Flash 2	off	off	off	off	off	Bright
	16.6~33.2%	off	off	off	off	Flash 2	Bright	off	off	off	off	Bright	Bright

SOC (%)	33.2~49.8%	off	off	off	Flash 2	Bright	Bright	off	off	off	Bright	Bright	Bright
	49.8~66.4%	off	off	Flash 2	Bright	Bright	Bright	off	off	Bright	Bright	Bright	Bright
	66.4~83%	off	Flash 2	Bright	Bright	Bright	Bright	off	Bright	Bright	Bright	Bright	Bright
	83~100%	Flash 2	Bright	Bright	Bright	Bright	Bright	Bright	Bright	Bright	Bright	Bright	Bright
Operating indicator		Bright						Flash (flash 3)					

**Table 4 LED Flash Notes**

Flash mode	Bright	off
Flash 1	0.25S	3.75S
Flash 2	0.5S	0.5S
Flash 3	0.5S	1.5S

**Remark:**

**LED indicator light alarm can be enabled or prohibited through the upper computer , factory default is enable.**

**4.3 Battery Connection and Communication Instructions**

RS485: With a dual RS485 interface to check PACK information, with a default baud rate of 9600bps. To communicate with the monitoring equipment through the RS485, the monitoring equipment as the host, according to the address polling data, address setting range of 2~15.

RS232: BMS can communicate with the upper computer through the RS232, RS485 interface, so as to monitor all kinds of information of the battery at the upper computer end, including battery voltage, current, temperature, state, SOC, SOH and battery production information, etc., the default baud rate is 9600bps.

CAN: With dual isolation CAN communication, default communication rate 500 K, active communication portal between battery and inverter.















Dial switch settings: when the PACK is used in parallel, different PACK can be distinguished by setting the address on the BMS dial switch, avoid to set the same address. The definition of the dial switch refers to the following table5 (A maximum of 30 groups can be configured)

















# Dial Switch Position Setting for Parallel Connection

Dial switch setting: when PACKS are used in parallel, different PACKS can be distinguished by setting the address on the BMS dial switch to avoid setting the same address(the PACK bottom board needs to be removed, then the dial code can be set, see picture on right).

The definitions of the dial switch refer to the following table

**Table 5 Dial Switch Positions**

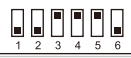
PACK NO.	ADDR.	Dial Switch Positions						Dial Switch Settings
		#1	#2	#3	#4	#5	#6	
PACK single used								
/	0	OFF	OFF	OFF	OFF	OFF	OFF	 ON OFF
PACKS in parallel								
1 <sup>st</sup> PACK	1	ON	OFF	OFF	OFF	OFF	OFF	 ON OFF
2 <sup>nd</sup> PACK	2	OFF	ON	OFF	OFF	OFF	OFF	 ON OFF
3 <sup>rd</sup> PACK	3	ON	ON	OFF	OFF	OFF	OFF	 ON OFF
4 <sup>th</sup> PACK	4	OFF	OFF	ON	OFF	OFF	OFF	 ON OFF
5 <sup>th</sup> PACK	5	ON	OFF	ON	OFF	OFF	OFF	 ON OFF
6 <sup>th</sup> PACK	6	OFF	ON	ON	OFF	OFF	OFF	 ON OFF
7 <sup>th</sup> PACK	7	ON	ON	ON	OFF	OFF	OFF	 ON OFF
8 <sup>th</sup> PACK	8	OFF	OFF	OFF	ON	OFF	OFF	 ON OFF
9 <sup>th</sup> PACK	9	ON	OFF	OFF	ON	OFF	OFF	 ON OFF
10 <sup>th</sup> PACK	10	OFF	ON	OFF	ON	OFF	OFF	 ON OFF
11 <sup>th</sup> PACK	11	ON	ON	OFF	ON	OFF	OFF	 ON OFF
12 <sup>th</sup> PACK	12	OFF	OFF	ON	ON	OFF	OFF	 ON OFF
13 <sup>th</sup> PACK	13	ON	OFF	ON	ON	OFF	OFF	 ON OFF

PACK NO.	ADDR.	Dial Switch Positions						Dial Switch Settings	
		#1	#2	#3	#4	#5	#6		
14 <sup>th</sup> PACK	14	OFF	ON	ON	ON	OFF	OFF		ON OFF
15 <sup>th</sup> PACK	15	ON	ON	ON	ON	OFF	OFF		ON OFF
16 <sup>th</sup> PACK	16	OFF	OFF	OFF	OFF	ON	OFF		ON OFF
17 <sup>th</sup> PACK	17	ON	OFF	OFF	OFF	ON	OFF		ON OFF
18 <sup>th</sup> PACK	18	OFF	ON	OFF	OFF	ON	OFF		ON OFF
19 <sup>th</sup> PACK	19	ON	ON	OFF	OFF	ON	OFF		ON OFF
20 <sup>th</sup> PACK	20	OFF	OFF	ON	OFF	ON	OFF		ON OFF
21 <sup>th</sup> PACK	21	ON	OFF	ON	OFF	ON	OFF		ON OFF
22 <sup>th</sup> PACK	22	OFF	ON	ON	OFF	ON	OFF		ON OFF
23 <sup>th</sup> PACK	23	ON	ON	ON	OFF	ON	OFF		ON OFF
24 <sup>th</sup> PACK	24	OFF	OFF	OFF	ON	ON	OFF		ON OFF
25 <sup>th</sup> PACK	25	ON	OFF	OFF	ON	ON	OFF		ON OFF
26 <sup>th</sup> PACK	26	OFF	ON	OFF	ON	ON	OFF		ON OFF
27 <sup>th</sup> PACK	27	ON	ON	OFF	ON	ON	OFF		ON OFF
28 <sup>th</sup> PACK	28	OFF	OFF	ON	ON	ON	OFF		ON OFF
29 <sup>th</sup> PACK	29	ON	OFF	ON	ON	ON	OFF		ON OFF
30 <sup>th</sup> PACK	30	OFF	ON	ON	ON	ON	OFF		ON OFF

## 4.4 Interface Diagram



1 2 3 4

Dry Connection Port

The definition of dry connection port: Pin1 to pin 2 always open, close when broken and protection, Pin3 to Pin4 always open, close when low SOC alarm.

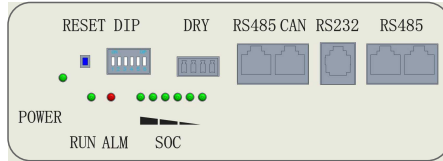

**Table 5 Communication interface table**

		RS485B-8P8C		RS485B-8P8C	
		RJ45		RJ45	
Parallel communication		1,8	RS485-B	9,16	RS485-B
		2,7	RS485-A	10,15	RS485-A
		3,6	GND	11,14	GND
		4,5	NC	12,13	NC
External communication		RS485A port		CAN port	
		RJ45		RJ45	
		1,8	RS485-B1	1,2,3,6,8	
		2,7	RS485-A1	5	CAN-L
		3,6	GND	4	CAN-H
Communication with host computer		RS232		RJ11	
		RJ11		RJ11	
		1	NC	4	RX
		2	NC	5	GND
		3	TX	6	NC

## 4.5 Display rendering



### Main menu page

After BMS is activated, will show the welcome screen, press the “MENU” button to enter the main menu page. As shown in the figure below:

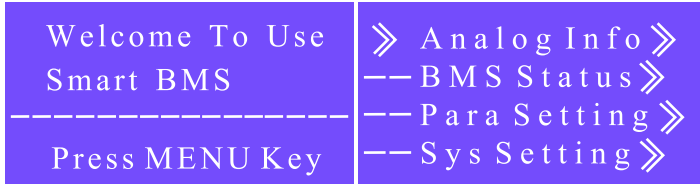

### Battery parameters page

When the cursor “ » ” is point to “Battery Parameters Acquisition” , press “ENTER” key will enter the page of “Battery Parameters Acquisition” , As shown in the figure below:

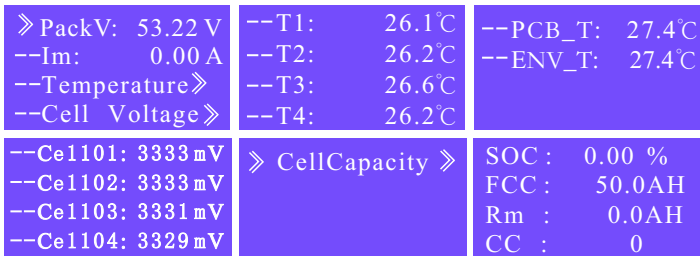

### Protocol selection function

(You can switch protocols through the display screen to quickly match inverters of different brands)

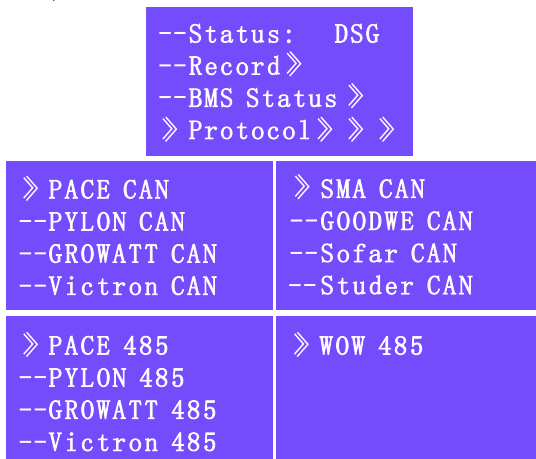

When the cursor “»” is point to” Battery Status”, press “ENTER” key will enter the page of “Battery Status” , As shown in the figure below:

<pre> » Status: IdIe --Record» --BMS Status»         </pre>	<pre> » OVP :      0         </pre>	<pre> » UV :       N --UVP:      N --OC:       N --OCP:      N         </pre>
<pre> » SCP:       0 --0/UTP:    0 --OCP:      0 --UVP:      7         </pre>	<pre> » SCP:       N --Failure :  N         </pre>	<pre> » OT :       N --OTP:      N --OV:       N --OVP:      N         </pre>

**Parameter Settings**

Screen can not set parameters Baud Rate : 9600, Can not be set.

<pre> --Non-production manuf ac turer can not use.         </pre>	<pre> --Baud rate:9600         </pre>
-------------------------------------------------------------------	---------------------------------------

**Key description**

SW1----MENU, SW2----ENTER , SW3----DOWN , SW4----ESC.

Each item is “»” or “--” as a beginning , among them “»” shows the current cursor position, press “DOWN” key can move the cursor position ; with “»” end of the project, the content of the said project has not shown, press “ENTER” key can enter the corresponding page.

Press “ESC” key can be returned at the next higher level directory ; In any position , press” MENU” key can return to the main menu page.

When BMS inter sleep mode, press any key, can activate the screen.

Inter standby mode, with no keystrokes 1 minutes later, LCD will enter Shutdown mode press any key, screen can be activated.

## 5. Battery Installation Instructions

### 5.1 Installation location

Make sure that the installation location meets the following conditions:

The building is designed to withstand earthquakes.

Far away from the sea to avoid salt water and humidity.

The floor is flat . and no specific restrictions on ventilation conditions.

No flammable or explosive materials nearby.

Optimal ambient temperature is between 25°C and 55°C.

Temperature and humidity stays at a constant level.

Minimal dust and dirt in the area.

No corrosive gases present, including ammonia and acid vapor.

BSL batteries are IP20, so the battery could be only installed indoors.

If the ambient temperature is outside the operating range, battery will protect itself by shutting down. The battery optimal operate temperature is 25°C to 55°C. Frequent exposure to severe operating condition would exacerbate the performance and lifetime of the battery.

### 5.2 Installation Tools

To install the battery pack, those following tools are probably required:









			
Phillips screwdriver	Torque wrench	Cable crimper	Wire clamp
			
Voltmeter	Tape measure	Drill	Flat-head screwdriver
			
Insulated glove	Safety goggles	Safety shoes	

Figure 4

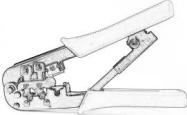
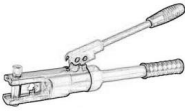

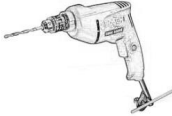
Space requirements: Observe the minimum clearance of the walls, other batteries or objects shown in the figure below to ensure adequate heat dissipation.

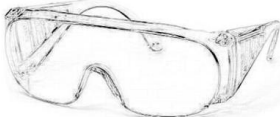
Direction	Minimum clearance (mm)
Upper side	300
Underside	300
Side	500
Front	300

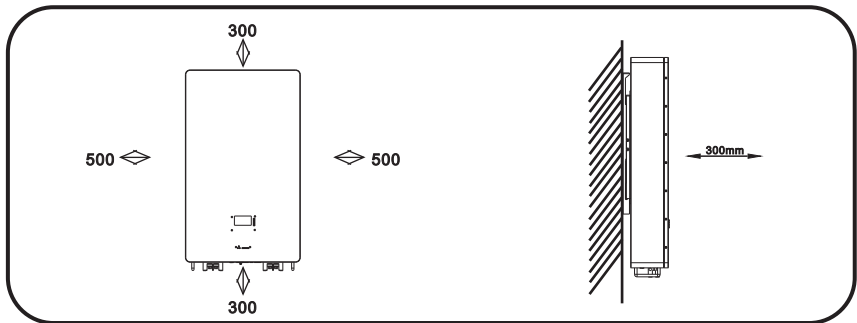

Step 1: install the wall mounted bracket to the wall;

Place the bracket on the wall, mark the position of the six holes and remove it;

1.2 Drill holes with a hole depth above 60mm to ensure sufficient strength to support the battery pack;

1.3 Install the expansion screw in the hole and tighten it, then fix the wall mounted bracket with the expansion screw;

Step 2: Hold the handle at the bottom of the battery, hang the battery pack on the wall mounted bracket;

Step 3: Tighten the setscrews on left and right sides of the battery pack.

### 5.3 Installing battery strings

Taking one batteries as an example, lines are used to combine the positive and negative outputs of one batteries:

First, refer to the figure below to define the primary and slave batteries.

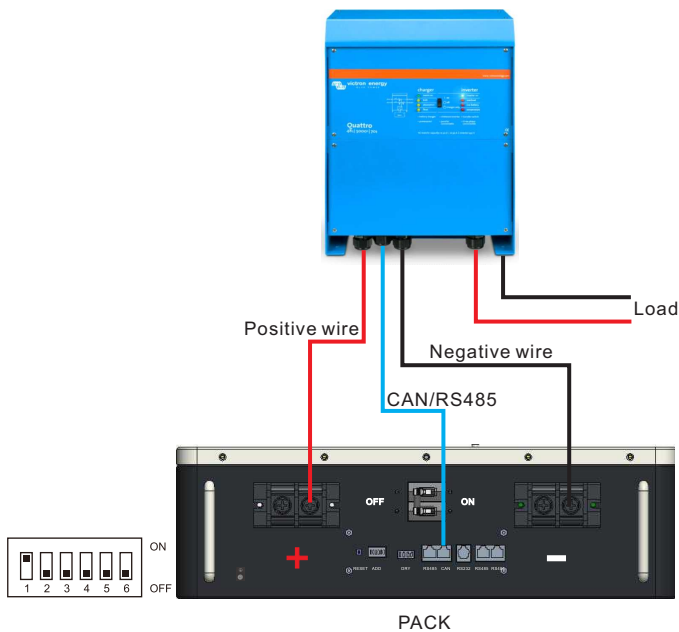

Note: For AU market, an overcurrent protection and isolation device that isolates both positive and negative conductors is required between battery and inverter.

Connect the positive electrode of the main battery to the positive electrode of the inverter. Connect the negative electrode of the main battery with the negative electrode of the inverter.

The port of the main battery is connected to the CAN bus communication port of the inverter.

If necessary, add appropriate isolation between the appropriate isolation or the main battery pack and the inverter.

Start and stop battery pack. Confirm that the operation is correct, and the battery function can be turned on after the wiring is correct, and you can press down power switch (ON/OFF) 3 second for start battery pack, then turn on switch in the breaker, the battery start working and output, it enter standby mode (if there is no power switch, please use a little pole and press down the RESET key 3-6 seconds, LED indicate all running status and check itself).

Running the device, set the external charger or inverter parameters, please set according to the corresponding operation manual. Can not exceed the rated parameter requirements.

## 5.4 Installing battery strings in parallel

Taking two batteries as an example, two parallel power lines are used to combine the positive and negative outputs of two batteries:

First of all, connect the battery pack with parallel communication lines (chrysanthemum chain mode); Any Pack has 2 PCS RS485B port for parallel communication, 1 PCS RS485A and 1PCS CAN port for inverter or other device. RS232 port only used for host software and update the firmware.



Then the battery pack grounding harness is installed to ensure the safety and protection measures of the electrical system.

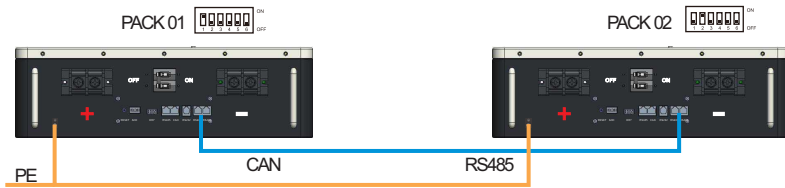

Finally connect the positive output line and the negative output line according to the number of parallel batteries (After installation, fasten the screws on the insulation protection buckle on the positive terminal port with a torque of 12.75-15.67N.m);

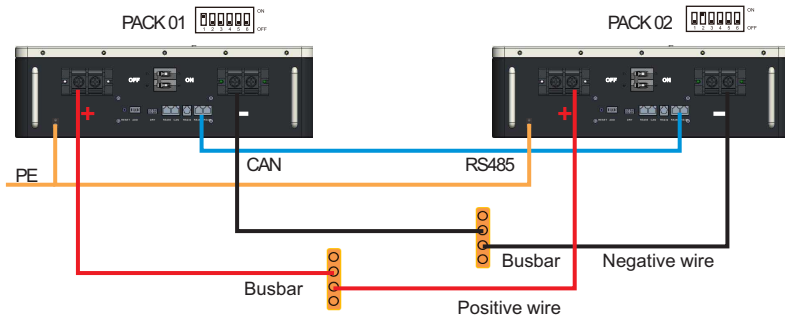

Start and stop battery pack.

Starting battery: Confirm that the operation is correct, and the battery function can be turned on after the wiring is correct, and You can press down power switch(ON/OFF) 3 second for start battery pack, then turn on switch in the Breaker, the battery start working and output, it enter standby mode (if there is no power switch, please use a little pole and press down the RESET key 3-6 second, like as follow picture, LED indicate all running status and check it's self).

Turn off the battery, Turn off the circuit breaker, turn off the output of the battery, press the reset button for 3-6 seconds, and then turn off the LED after blinking (on the premise that there is no communication), and power off the battery system as a whole.

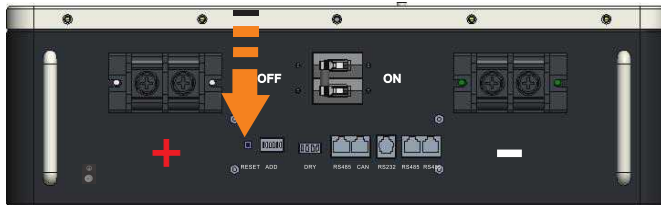

First, refer to the figure below to define the primary and slave batteries.

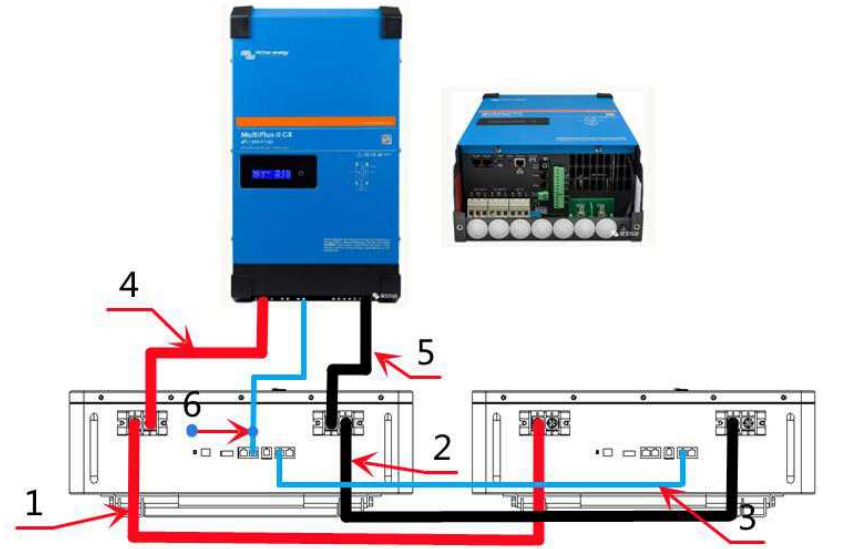

For Australian Market, an overcurrent protection and isolation device that isolates both positive and negative conductors is required between the battery system and the inverter, and between parallel batteries.

When the equipment manufacturer confirms that it is necessary, it can authorize to provide the customer with the host software and operating instructions.



Figure 7 RS232 Serial port communication device

Host soft operation:

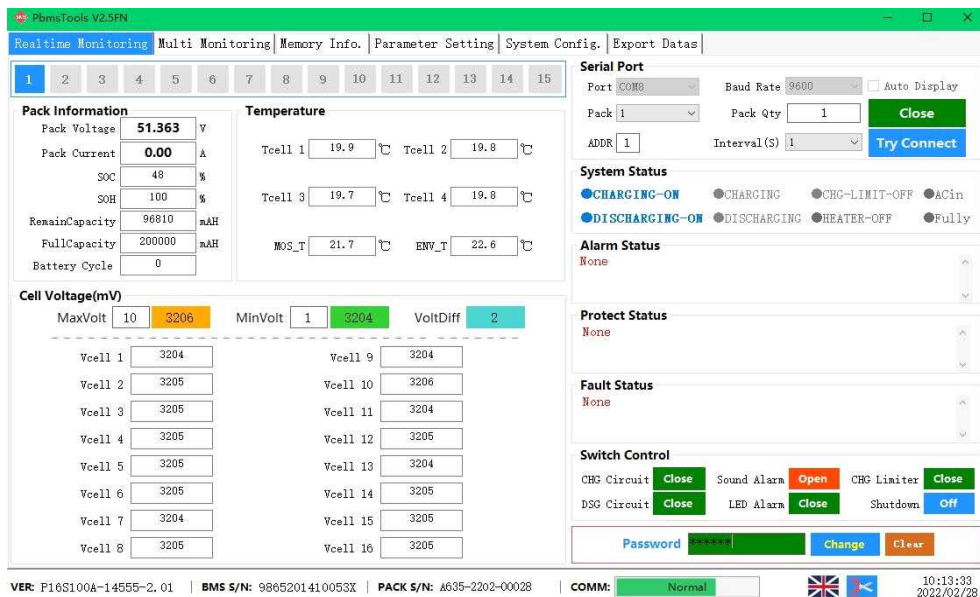

Figure 8

Multi Inverter protocol support.

Default setting: CANBUS - Victron, RS485-DEYE.

communication mode	Matching inverter factory	
CAN	Pylon	PYLONTECH
	Deye	Deye 德業
	Sunsysk	Sunsynk
	Growatt	Growatt
	Victron	victron energy
	Goodwe	固德威 GCODWE
	SMA	SMA
	Sofar	SOFAR 首航新能源
	Studer	Studer
	Kstar	KSTAR 科士达
	Megarevo	MEGAREVO
	schneider	Schneider Electric
	Must	MUST 美世乐
	Lux	LUXPOWER <sup>TEK</sup>
BSLBATT	BSLBATT	
RS485	Pylon	PYLONTECH
	Deye	Deye 德業
	Growatt	Growatt
	Voltron	Voltron Power
	Phocos	phocos
	Lux	LUXPOWER <sup>TEK</sup>
	Srne	srne

The screenshot shows the 'System Config' tab of the PbmsTools H51.0.6 software. The 'Inverter protocol' section is highlighted with a red box. It contains the following settings:

- DesignCapacity:** [Empty field]
- RemainCapacity:** [Empty field]
- FullCapacity:** [Empty field]
- Battery Cycle:** 0
- Inverter protocol:**
  - CAN Protocol: [Dropdown menu]
  - RS485 Protocol: [Dropdown menu]
  - Type: [Dropdown menu]
- Manufacture Information:**
  - Clear text box after writing
  - no-repeat EMS S/N: [Field] 20 [Write]
  - no-repeat PACK S/N (20): [Field] 20 [Write]

Other visible settings include Voltage (mV), Current (mA), Cell Number, CHG Current, Gap Charge, and Capacity (mAH).

Remark:

- Please ask your sales team to provide password for host computer software administration enter.

If needed, the network cable should be made like that diagram. But the network cable between battery and Inverter should be made following the definition of Inverter. If available, use a LAN cable tester to check whether the cable is faulty.

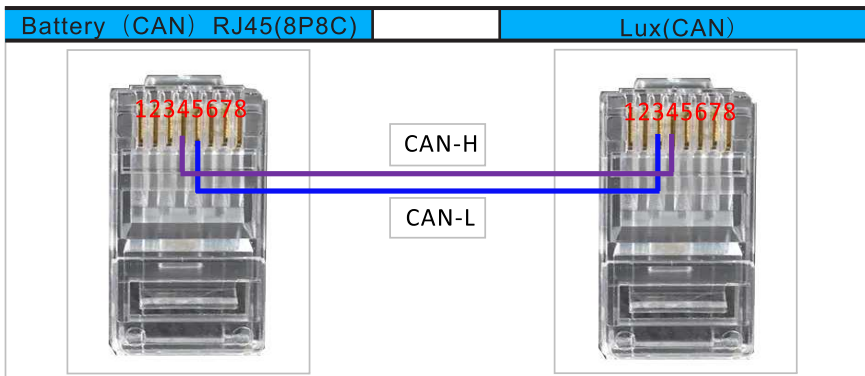
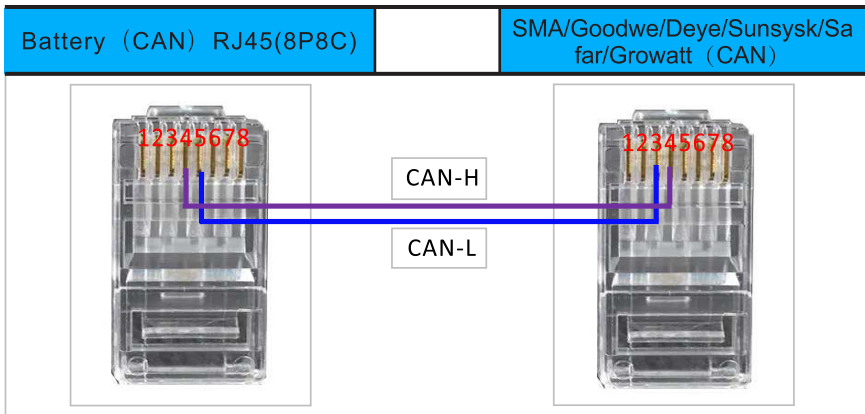
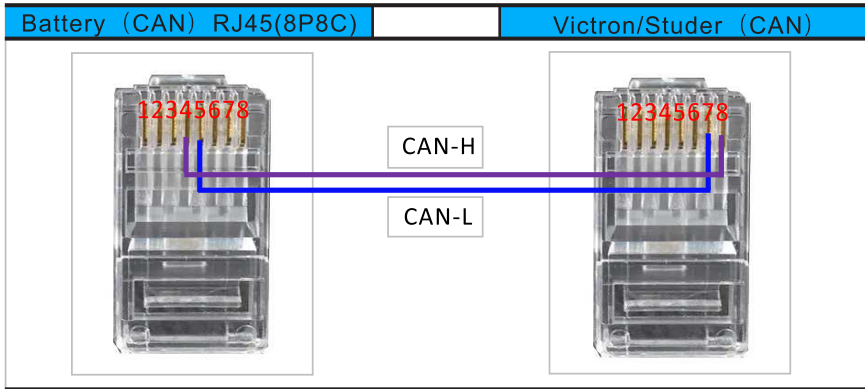

Battery (RS485) RJ45(8P8C)

Lux/Growatt (RS485)



RS485-B

RS485-A



Battery (RS485) RJ45(8P8C)

Voltronic (Rs485)

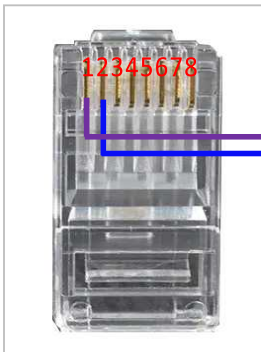

RS485-B

RS485-A



Battery (RS485) RJ45(8P8C)

Srne (RS485)

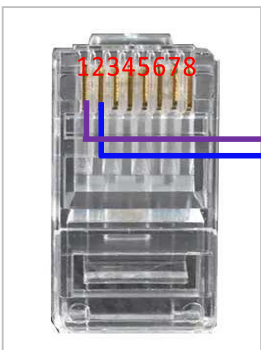

RS485-B

RS485-A

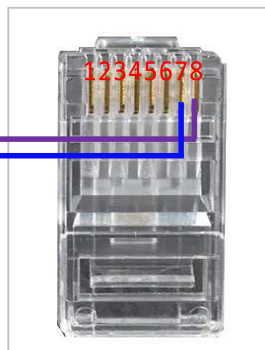



### Abnormal Situation Addressing

1.What if the battery pack does not work properly after power on?

A: The most direct way is to connect to the upper computer, through the upper computer to find the fault phenomenon, causes can be roughly analyzed from the upper computer interface prompt alarm, protection, fault and other information, it can also provide necessary reference for further testing.

2.Under what circumstances will RS232 communication fail?

A: The following steps can be taken to eliminate the problem:

1) Confirm that at least one of the indicator lights of the battery pack is on or flashing, that is, the battery pack is in normal working condition;

2) Confirm that the host computer software selects correct COM port (view device manager);

3) Confirm whether the RS232 communication line is fully inserted into the corresponding communication interface of the battery pack.

3.Under what circumstances will RS485 fail to paralleling batteries communication?

A: The possibility of failure of parallel batteries communication is as follows: first ensure whether the parallel RS485 communication port has been connected, and then make sure that the address dialing position of the battery pack is correct, and make sure that the RS485 terminal Plug-in in the right place.

4.What is the fault alarm mechanism?

A: battery pack has fault alarm function, can be checked through upper computer software.

Failure includes:

1) Sampling failure: analog front-end and main control chip communication failure. When the fault occurs, the charge and discharge function is turned off, and the fault alarm can be automatically cleared after the fault is cleared.

2) Temperature NTC failure: mainly detects whether the temperature NTC is short-circuited or disconnected. When the fault occurs, the charge and discharge function is turned off, and the fault alarm can be automatically cleared after the fault is cleared.

3) Cell failure: the voltage difference of the cell exceeds 1V, or the difference between the total voltage detection voltage and the sum of single cell voltage is more than 5V, or the minimum voltage is less than 0.5V. The voltage sampling line disconnect also reports the same fault. When the fault is cleared, the fault alarm can be automatically cleared.

After the battery is connected to the system and shows over-current protection or short circuit protection. This is not a problem with the battery pack, but the capacity load of the electrical

equipment is too large. Charging can remove the alarm, or extend the battery pack precharge circuit delay time.

**Product Responsibilities and Consulting**

We will not be liable for the accidents resulting from operation breaking this specification and user manual.

We will not send separate notice, provided that the contents of this specification are changed due to improvement

of product quality or technological upgrading; provided that you want to understand the latest information of

this product, please contact us.

The shelf life of this product is within 60 months after it is delivered; we will maintain the product, which is in the warranty period for free of charge, provided that it has any product.

quality problems within the specified operation range; we may replace the relevant parts, if we fail to maintain it,

so as to achieve the purpose of sustainable use without performance reduction; our after-sales service personnel

will propose the specific maintenance and troubleshooting methods.

In case of any questions, please contact us.

WARRANTY CARD			
Product Name		Model Number	
BATCH NO.		Shipping Date	
The Buyer		Phone	
Address			
<p>If a device becomes defective during the agreed warranty period, please report the defective device situation to the original manufacturer with this warranty card. Supplier or end users required to send the warranty claim form to the original manufacturer or authorized service partner with all the necessary information. Customers must present this warranty card, battery purchasing invoice, extension warranty letter if applicable, and other related materials as well if required. It is the responsibility of the warranty holder to substantiate the warranty claim and show that the conditions are met. Please note the original manufacturer reserve the ultimate explanation right on this warranty card.</p>			

THANK YOU FOR CHOOSING

LET’S DEVELOP TRUST AND BUSINESS